

# Energy efficient Hydroxy Gas generator

Ritesh Bhattacharya (corresponding author)

Department of mechanical engineering, Kanpur Institute of Technology, Kanpur,  
Mob. No.+919335378402 email:rkb439@rediffmail.com

Shakun Srivastava

Department of mechanical engineering, Kanpur Institute of Technology, Kanpur,  
Mob. No+919451918258 email:shakun227@gmail.com,

## Abstract

As requirement regarding energy consumption increases we are switching over the unconventional methods such as Nuclear Fuel, Solar Power etc, and In Present situation we have to take care of our environment also ,In many countries research are going on Unconventional resources of energies and different type of unconventional Fuels. Few researchers working on mixture of Hydrogen and oxygen(stoichiometric ratio 2:1, i.e Hydroxy Gas) , and use this mixture as a fuel in internal combustion engines ,As the calorific value of hydrogen is quite high so we can use this mixture as a fuel in all type of combustion heat engines. This type of Heat engines requires Hydrogen and oxygen mixture as a Fuel, so we require Gas generators which can Produce Fuel mixture (Mixture of hydrogen and oxygen) on demand. In present paper we will discuss such method in which we will limit the current to a minimum value (in order of miliampere) and water is separated by voltage simulation process.

**Keywords:-** Zero Point Energy, D.C Resonant Charging, Unipolar D.C Pulse, D-Qing Diode , Pulsing Transformer, Water capacitor, Dielectric breakdown of water.

**1. Introduction:-**This Invention relates to a method of obtaining an apparatus for release of Fuel gas mixture including Hydrogen and oxygen in stoichiometric ratio (2:1) from water efficiently[1]. It is object of the Invention to Provide a Fuel cell and Process in Which Molecules of water are Broken down in to Hydrogen and oxygen gases, and other formerly dissolved gasses within the water is Produced[2]. As used herein the term Fuel cell refers to a single unit of invention comprising a water capacitor cell in which water Performs as a dielectric medium between the capacitor the electrolysis process is not dependent on energy[3]. From Arrhenius theory, molecules in solution dissociate into ions and the ions are collected at the electrode. No energy is required for ionic dissociation and electrolysis processes are so efficient that they are used to measure current. When the Arrhenius theory is applied to the dissociation of water, the key requirement to produce 1 mole (~1 gram) of hydrogen is that 1 Faraday of electricity flows. If it is assumed that the hydrogen is produced by passing 1 amp of current for 96,494 seconds (1 Faraday = 96,494 coulombs) at 1 volt, then the energy needed is ~96.5 kJ. That same 1 gram of H<sub>2</sub> is capable of releasing 285kJ during the combustion process with oxygen. The process of producing hydrogen from water usually requires an electrolyte to produce it in quantities. Polarization occurs at the electrodes with hydrogen collecting there. A number of methods are known for improving the efficiency of the process [6]. In this theory we never us an electrolyte and the process can be made energy efficient without a breach of any of the laws of thermodynamics[10].

**1.2 Methodology:-**In ordinary water a small amount of the water dissociates into hydrogen and hydroxyl ions. These ions are immediately hydrated. The amount dissociating depends on the purity of the water and in very pure water is equal to 1 part in 10 million (10<sup>-7</sup>), or a pH of 7. Normally ordinary water is described as non-conducting. Hydrogen and hydroxyl ions are constantly being created and then decaying back to water, but there is always a balance between the numbers ionized and the numbers in solution. Under normal electrolysis these ions can be swept to electrodes and neutralized with the opposite charge. Hydrogen and oxygen can be produced. In conventional circuits, the energy used in collecting the hydrogen is greater than the energy that is available from the

hydrogen. We have utilized a novel electronic circuit which produces high voltages but prevents currents from flowing. This circuit is similar to a D.C resonant charging circuit in under damped condition[6]. The power to this circuit is coming from a Pulsing D.C voltage source which is across a capacitor with water between the plates[9]. The dielectric water itself provides the charge to charge up the capacitor and creates the high voltage. This charge comes from the hydrogen and hydroxyl ions. The more charge that flows the more the voltage builds up and the more ions are pulled out of solution. The circuit has a high frequency of the order of five kilohertz superimposed through the windings of the field coils. In addition, the circuit is equipped with D-Qing diode[7] does not allow the capacitor to discharge during pulsing operation. On the charging up side the ions are pulled out of the dielectric and moved towards the metal electrodes. On the discharging side they may go back into solution. The circuit succeeds in increasing briefly the number of ions which are out of solution. A portion of these ions are able to form hydrogen and oxygen by normal electrolysis type processes. The hydrogen and oxygen bubble to the surface. **The circuit is novel in that it is a form of electrolysis but there is no need for any net current to flow.** While the voltage applied is zero, the ionized charges are able to recombine without flowing around the circuit and using energy. Theoretically, there is no reason why the process cannot be totally efficient in producing hydrogen and oxygen. The efficiency depends on the tuning frequency of the LC circuit and having this balanced with the mobility of the ions and the spacing between the plates. There may also be a need to allow a definite relaxation time after each pulse, to increase the period in which the ionized charges may recombine and hydrogen and oxygen may be collected. **The process does not defy the laws of thermodynamics in that the energy comes from the energy of dissociation of the molecules.** A portion on the molecules are dissociating and associating automatically all the time. In the normal course of events, this does not change the energy of the water. This process interrupts this cycle and allows a person to form water in the stable state of diatomic hydrogen and oxygen. The process is not dissimilar to the vaporization of water which takes place naturally. The water forms clouds, then rain. Rivers flow and energy is extracted from the rivers. The difference is that it is possible to carry out the cycle under laboratory type conditions or industrial type conditions and extract the energy in the form of hydrogen. By developing a process to utilize the hydrogen ions directly on formation, a great deal more energy will be available and this is intention in terms of adaption of this fuel cell for an ordinary car[13].

### 1.3 The energy Balance

Where does the energy come from? Effectively, the water molecule is marginally unstable in water solution and is constantly acting as a 'radioactive' molecule, tossing out  $H^+$  and  $OH^-$  ions. The energy of the process comes from the formation energy of these ions.

Born-Haber Cycle For Above Process (similar to Boyce process):

All energies in kJ/mol

H -OH Dissociation Energy + 494

$H^+$  Ionization +1310

Hydration of  $H^+$  to form  $H_3O^+$  -1075

Electron Affinity of  $OH^-$  - 223 (Assumed affinity is between that of O and Cl)

Total: +506 kJ/mol

In normal water, a portion of the ions are dissociated. For pure water, this is one in 10 million ( $10^{-7}$ ) or a pH of 7. Initially,  $H^+$  and  $OH^-$  are formed but are immediately hydrated to  $H_3O^+$  and  $OH^-$ . From the above for the  $H_3O^+$  and  $OH^-$  ions, the energy of formation is 506 kJ/mol. The process occurs naturally without any electrical input, etc. If these ions are removed, more are produced by the water. This process can be explained by quantum mechanics. The atoms in the molecule will have 'zero point energy' of vibration and therefore there is a finite chance of dissociation. With high electric fields, this chance would be greatly increased. The release will also be affected by

the presence of other ions which again affect the potential. Once released, the full energy of dissociation will be available as energy.

The hydronium ions and the hydroxyl ions formed by this process may form gases by the following process:

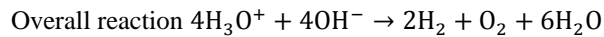
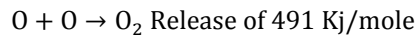
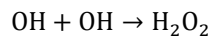
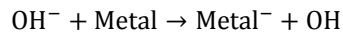
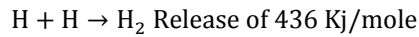
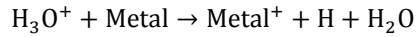

As it takes 2 H atoms to form H<sub>2</sub>, only half of the energy of the 436 KJ will be involved in the process. As it takes 2OH to produce H<sub>2</sub>O<sub>2</sub>, only half of the energy of this reaction will be involved in the process. For the formation of O<sub>2</sub>, it will take 4 OH radicals and therefore one quarter of energy will apply in this case. The theory focuses on the basic structures of hydrogen and oxygen atoms and how they are combined in the water molecule. Note the orbital path of the electrons and their 'shells'; the magnetic polarity of an electron and a nucleus; and the space occupied by the so-called vacuum. Note the presence of the two hydrogen atoms in the 'L' shell of the oxygen atom. These are known as the covalent electrons which are bonded in position by considerable force. **In the case of normal electrolysis, the energy needed to break these bonds and produce separate hydrogen and oxygen atoms from water is roughly three times the energy of the hydrogen bond released.** It is thus a highly inefficient process because of the considerable amount of waste heat which is generated. The energy extracted by this process is derived from two distinct but virtually simultaneous processes. The first, the hydrogen fracturing process which dissociates the hydrogen gas from the water molecule and the second, the electron ionization process which enhanced the explosive energy of the gases released. **The basis of this process is the subjection of the water molecule to very high voltage (2000+) pulses at a particular frequency and within positively and negatively charged voltage zones at a very low current (in order of milliamp). The effect is to attract the negatively charged electrons towards the positive voltage zone and the positively charged nucleus towards the negative zone.** The electron orbital path is changed from a circle to an ellipse and this, coupled with the effect of pulsing, causes such electrical stress on the molecule that the covalent bonds between the hydrogen and oxygen atoms are broken and the two gases are separated. Therefore, they require substantial energy to be applied before they can be recombined. Because the current is so low, very little heat is generated. It is worth noting that, weight for weight, hydrogen contains about 2.5 times the energy of gasoline and the latent energy in the hydrogen content of a pint of water amounts to over 9 million joules, or enough to run a 2500 watt load for an hour. Two distinct questions arise over explosive energy enhancement. First, where does the additional energy come from? And second, how is it to be obtained and controlled? **The answer to the first question is the so-called vacuum within the electron shells. For many years, this vacuum was regarded as a void. But James Clerk**

**Maxwell, in his 'Treatise on Electricity and Magnetism' published in 1873, pointed out that the vacuum in fact contains a considerable amount of energy. Subsequent work bears this out and it is now generally accepted that the vacuum is in fact seething with energy which has been variously described as, for example, 'universal energy', 'gravity field energy' or 'Zero Point Energy' (ZPE)[3]. John Archibald Wheeler of Princeton University and a leading physicist who worked on the US atomic bomb project, has calculated that the flux density of ZPE is of the order of  $10^{93}$  grams per  $\text{cm}^3$ .** It is also recognized that the state of this so called 'sea of energy' is chaotic. Hence, it needs to be 'engineered' or made coherent before it can be translated from a microscopic to a macroscopic state. In other words, it requires special treatment before it can be tapped and controlled for normal external use. Various answers, mostly theoretical, have been given to the second question The technical basis for extraction and control of ZPE lies mainly in the effect produced on an atomic nucleus by continuation of the same high voltage pulsing that causes the dissociation of the water molecule. The nucleus consists of one or more positively charged protons bound together with a number of neutrally charged neutrons. The electrical effect of the electron pumping action mentioned earlier causes an annulus to appear in the middle of the nucleus. The ZPE is drawn in a helical motion through the annulus and, in doing so, becomes coherent and hence a usable source of energy. **The voltage dictates the size of the annulus and hence controls the energy obtained.** Since the basic structure of the atom is retained no alpha or gamma radiation occurs. The effect might be illustrated by a bath full of water. So long as the plug is in place, the water remains still and apparently powerless. However, when the plug is removed, the water swirls away with a helical motion down the plug hole and, under the influence of gravity, forms a powerful jet which can be directed to do work.

**Above said phenomena does not infringe the two main laws of thermodynamics.** The First Law of Thermodynamics states that the total energy of a thermodynamic system remains constant although it may be transformed from one form to another. In the case of above, the system under consideration is global. The energy required to drive the engine comes from the ZPE contained in water, a virtually inexhaustible source. **The exhaust from the engine is water vapor which returns to the atmosphere.** The Second Law of Thermodynamics as originally formulated by R. Clausius in 1865 states that the entropy of the world strives towards a maximum. As recently formulated by Prigogine and Stengers, this law contains two fundamental elements: (1) a negative one that expresses the impossibility of certain processes (e.g., heat flowing from a cold to a hot source) and (2) a positive, constructive one. It is the impossibility of certain processes that permits us to introduce a function, entropy, which increases uniformly and behaves as an attractor for isolated systems. It is at maximum when the system is in equilibrium. Non equilibrium is the source of order and brings order out of chaos. Since This technology postulate non equilibrium, it can be said to be supported by the positive element of this law.

**1.2.1 Circuit Analysis:** The water fuel cell uses a electrical circuit for die electric breakdown of water. Here water performs as a dielectric medium (dielectric constant 78 at  $25^{\circ}\text{C}$  ,within concentric cylinders, this capacitor is in series with inductors (L1&L2) which receives straight unipolar D.C Pulse from a Pulse generator and a step up Pulsing Transformer.(Toroidal core).**fig-1**. In above circuit The variable Inductor (To maintain the damping ratio and Natural Frequency of circuit constant) and resonant charging choke has combined inductance "L" and water capacitor has capacitance "C" and Blocking diode 1N1998 is De-"Qing diode" which does not allow to Discharge the capacitor during Pulsing operation. As we analyze circuit between the time 0 to  $2\pi\sqrt{LC}$  according to assume wave form of Pulsing transformer output (pulsing frequency= $\frac{1}{2\pi\sqrt{LC}}$ ) between the time interval 0 to  $\frac{2\pi}{3}\sqrt{LC}$  voltage is  $V_S$ , voltage across the capacitor  $V_C$  will be govern by the second order differential equation

$$LC \frac{d^2}{dt^2} V_C + RC \frac{dV_C}{dt} + V_C = V_S, \text{ Where } V_S \text{ is the output of pulsing Transformer?}$$

The solution to above differential equation in Under-Damped oscillation will be given by  $V_C = V_S + e^{\frac{-Rt}{2L}} K \sin(\gamma t + \theta)$  (1.1)[6] where R resistance of the circuit, C is capacitance of water fuel cell, L is total inductance of circuit, constants K and  $\theta$  can be calculated from the initial conditions. Here we set Pulsing frequency equals to or multiple of natural frequency of damped oscillations.**fig-2**The pulse off time will be regulated by the Variable Pulse

generator, During the Pulse-off time water molecule get settled after the capacitor discharged, Evaluation of Gasses is happened in this time period. After the Pulse off Time Water molecules are ready for the Next excitation Process.

**Case I**  $0 < t < \frac{2\pi\sqrt{LC}}{3}$  At  $t=0$ ,  $V_C=0$  and  $\frac{dV_C}{dt}=0$  as at the beginning of pulse both current and voltage is zero, So equation (1.1) at  $t=0$  gives  $\tan \theta \approx \frac{1}{\epsilon}$  where  $\epsilon$  is damping ratio and it is less than 1 and we choose for example here  $\epsilon = 0.165477$  so  $\theta = 80^\circ$ . so in calculations point of view we will neglect  $\epsilon^2$  in comparison to 1. as  $\epsilon^2 \ll 1$  and the term  $\gamma$  in equation (1.1) will be given by  $\gamma = \frac{\sqrt{1-\epsilon^2}}{\sqrt{LC}} \approx \frac{1}{\sqrt{LC}}$  and damping ratio  $\frac{\epsilon R}{L} = \frac{R}{L} \sqrt{\frac{C}{L}}$ . The constant  $K = -\frac{V_S}{\sin \theta}$ . So voltage across the capacitor at  $t = \frac{2\pi\sqrt{LC}}{3}$  will be given by  $V_C = V_S - \frac{V_S}{\sin \theta} e^{-\left(\frac{\epsilon R}{L} \frac{2\pi\sqrt{LC}}{3}\right)} \sin\left(\frac{2\pi}{3} + \theta\right)$  (1.2) Putting the values of  $\theta$  we get  $V_C = 1.24V_S$

**Case-II**  $\frac{2\pi}{3}\sqrt{LC} \leq t \leq \frac{4\pi}{3}\sqrt{LC}$

Due to De-“Qing Diode”[7] the capacitor would not discharge and it would not charge with reverse Polarity. And due to Inductor the current will not be instantly zero and it Keeps flowing in same Direction. So voltage across the capacitor from time  $t = \frac{2\pi\sqrt{LC}}{3}$  to time  $t = \frac{4\pi\sqrt{LC}}{3}$  will increase. As this time Inductor will act as a Power source so voltage across the capacitor between above time Period will be given by equation (1.1) Again by the equation (1.1) we get  $V_{C2} = V_S + \frac{V_S}{\sin \theta} e^{-\frac{4\pi}{3}\sqrt{LC}} \sin\left(\frac{\pi}{3} + \theta\right)$  again putting the values of  $\theta = 80^\circ$  and  $\epsilon = 0.165477$  we get  $V_{C2} = 1.32V_S$  (1.3) Similarly if we calculate voltage across the capacitor at time  $t = 2\pi\sqrt{LC}$ . we get  $V_{C3} = V_S - V_S e^{-\frac{2\pi}{3}\sqrt{LC}}$  (1.4) which is less than  $V_S$ . Analyzing the equation (1.2) and equation (1.3) and (1.4) we can say that voltage across the capacitor is increasing and we get  $V_C \approx 2V_S$  in the (although one may check that if  $\epsilon = 0.0001$  we get  $V_{C2} = 2V_S$  at  $t = \pi\sqrt{LC}$ ) time  $\frac{5\pi}{9}\sqrt{LC} < t < \frac{14\pi}{9}\sqrt{LC}$  (1.4 A), the maxima of the voltage will occur only one time in a Time Period of Pulse Train, so Pulsing Frequency should be Equal or Multiple of Natural Frequency of oscillation, so that at Pulse-off Time we get the heights Potential difference across the capacitor. Here De-“Qing diode” Prevents the current to flow in reverse direction, and the current flows within the capacitor only. **Fig-3** shows how the capacitor discharges in The Pulse-off Time, and charges in stepwise manner in Pulse-on Time. at Time of Break-Down of water High current Flows, This high current is Sensed by the electrical circuit and current limiting switches off the Pulses and during discharging of capacitor and when current drops up to certain limit, Pulse train Reapplied..

#### 1.4.1 Calculation of Electric Field For dissociation of water in Bulk (On The basis of dielectric breakdown of water Test)

The electric Field necessary for possible dissociation of water caused by the effect of Field between the electrodes is given by  $E_D = \Delta H/\mu$  where  $\mu$  is dipole moment of water molecule. With  $\Delta H = 286$  KJ/mole and  $\mu = 2$  Debye  $E_D = 7 \times 10^8$  V/cm which is much higher. As we

use cylindrical capacitor The Electric Field inside the capacitor is given by  $E \propto \frac{1}{r}$  where  $r$  is distance from inner diameter, so the Field near the electrode is much higher compare to bulk in the solution. Hence break down of water happens near the electrode surface not in the bulk in the solution[5].

**1.4.2 Dependency of electrode separation on Breakdown voltage** It can be depicted from **water dielectric breakdown test** results that as we increase the gap between the capacitor plates the break down voltage increases so we must have optimum gap between the capacitor plates, it is to be further mentioned that the gap between the capacitor plates should not less than a minimum value so that arc would not occur. Although it may be kept up to 2 to 3 mm according to dielectric breakdown test[5].

**1.4.3 I-V Relationship up to Breakdown:-** On the basis of water breakdown test following curves is obtain in current and potential applied to cell. **Fig-4** According to eq.(1.1) current in the circuit will be given by  $C \frac{dV_c}{dt} = i = \frac{-R}{2L} e^{\frac{-R}{2L} t} K \sin(\gamma t + \theta) + K \gamma e^{\frac{-R}{2L} t} \cos(\gamma t + \theta)$  (1.5) and at  $t=0$  current in the circuit will be zero. So eq (1.5) reduce to  $i = \frac{CV_s}{\sin \theta} e^{\frac{-R}{2L} t} \sin\left(\frac{t}{\sqrt{LC}}\right)$  (1.6) which is increasing form  $0 < t < \frac{\pi\sqrt{LC}}{2}$ , and in time interval  $\frac{5\pi}{9}\sqrt{LC} < t < \frac{14\pi}{9}\sqrt{LC}$  voltage reaches its maximum value according to (1.4 A), and between the time interval  $\frac{\pi\sqrt{LC}}{2} < t < \frac{5\pi}{9}\sqrt{LC}$  solution enters in the Plateau region in which current remains constant. Further increment of voltage across the capacitor results dielectric breakdown of water of water. Here it is Clearly seen that current will be in order off milliamps before breakdown as capacitance of water in order of microfarad, Here C to D is Plateau region **Fig-4**, Which is different for different types of electrodes[5].

**1.4.4 Breakdown:-** According to water break down test results , **Break down occurs at Point D** of Fig-4 end of the Plateau region. (On dielectric breakdown of water, Vol. 136, No. 9, September 1989 \_9 The Electrochemical Society)[5] .According to Dielectric breakdown test on water we use the fact here that breakdown of water occurs at **4000v to 5000v** For **Fe** electrode with electrode spacing 2 to 3 mm and it is between **3000v to 4000v** For Platinum electrode for same electrode spacing.

**1.5 Results:-** From the above discussion we can outline Following Results

1-Voltage require for Dissociation for water can easily obtain across the capacitor Plates by applying Few hundred volts(500v to 600v) to Primary winding of Pulsing Transformer .(secondary winding =5xPrimary winding)

2-Due to dielectric breakdown of water mixture of hydrogen and oxygen (in 2;1) ratio is obtain

3-By adjusting the Pulse Frequency we can get highest gas output.

4-As before the breakdown of water very Low ampere current flows so Power consumption is very less

5- Plate spacing of capacitor will be 2 to 3mm.

6-Break down occurs near the electrode plates and not in the bulk in the solution.

**1.5 Future scope:-** If we compare heat of combustion (burning with Oxygen) of Hydrogen Gas with other fuels which is tabulated as Follows **table-1**

According to above table we can say that hydrogen is efficient fuel regarding heat of combustion, As the hydroxy Gas Produce here has the same stoichiometric ratio (2:1), when we use hydrogen as a fuel which is burning with air, So we can frequently use hydroxy gas as a Fuel in our heat engines. The hydroxy Gas Produce Here requires less electrical Power than normal electrolysis Process. This system is Non Polluting because the emission of heat engines running on Hydroxy Fuel is Mainly Water vapors [8].

**Conclusions:-** The above describes such method in which Hydroxy Gas can be Produce in energy efficient way and the hydroxy Gas can be Fuel of future vehicle. The above Process can be treated as Free energy device although

water purification coast is not add here, If it is add despite of that this Process would be cheaper and echo friendly also.

**References:-**

- 1-Raum & zeit: U.S; Vol.2 No.1 ~ Birth of new technology
- 2-Raum & zeit: U.S Vol.3 No.4 ~ Birth of new technology
- 3-“Quest For zero Point energy” (Published by Adventures unlimited Press) by Moray B.King-Author of “Tapping the Zero Point energy”
- 4-US Patent No 4,421,474 ~ Hydrogen Gas Burner
- 5-On dielectric breakdown of water, Vol. 136, No. 9, September 1989 \_9 The Electrochemical Society, Inc.Marek Szklarczyk,Ramesh C Kainthla
- 6-Module-3 D.C Transient Version 2 EE IIT Kharagpur ([http://nptel.iitm.ac.in/courses/Webcourse-contents/IITKharagpur/BasicElectricalTechnology/pdf/L-11\(GDR\)\(ET\)\(\(EE\)NPTEL\).pdf](http://nptel.iitm.ac.in/courses/Webcourse-contents/IITKharagpur/BasicElectricalTechnology/pdf/L-11(GDR)(ET)((EE)NPTEL).pdf) )
- 7-Instruction book for the 6575 Modulator ,By Carl Olson, in Aug 1975,Stanford linear Accelerator centre
- 8- -“ Hydrogen oxygen reaction mechanism and its implication hydrogen engine combustion”-L.M Das ,centre for energy studies, Indian Institute of Technology , New Delhi, India
- 9- “New High voltage Pulse Generators” by Abbas Pourzaki and Hossein Mizaee, Department of Electrical and Electronic Engineering, Khorasan Research Institute for Food Science & Technology, Mashad, Iran
- 10-Zero Point energy (McGraw-Hills , Book) -Thomas Valone
- 11-A practical Guide to free energy devices, Part-D6 Author-Patrick.J.Kelly 12th February 2008
- 12-Practical conversion of zero Point energy (McGraw-Hills, Book)-Thomas Valone
- 13-On-Board Brown Gas Generation and Supplementation work-George Wlsemann March 16 2011

**Fig-1**

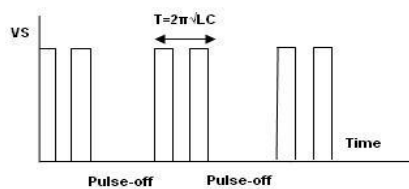
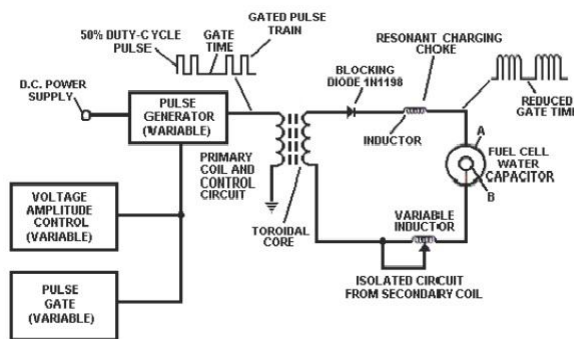

**Fig-2 Output Wave form of Pulsing Transformer**

**Fig-2 Output Wave form of Pulsing Transformer**

**Fig-3**

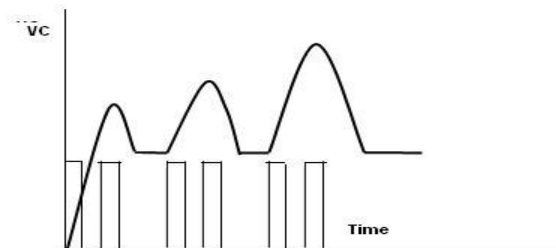

**Fig-3 variation of capacitor voltage(VC) with respect to Time in Gas generator electrical circuit**

**Fig-4**

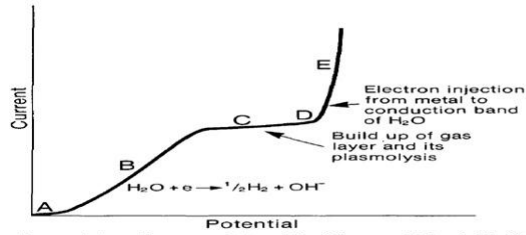

**Fig. Schematic representation of the i-V curves obtained with different electrodes in pure water.**

**Table-1**

Fuel	Kj/kg	Kcal/g	Fuel	Kj/kg	Kcal/g	Fuel	Kj/kg	Kcal/g
Hydrogen	141.9	33.9	Diesel	45.0	10.7	Ethanol	29.7	7.1
Gasoline	47.0	11.3	Natural Gas	34.0	13.0			



This academic article was published by The International Institute for Science, Technology and Education (IISTE). The IISTE is a pioneer in the Open Access Publishing service based in the U.S. and Europe. The aim of the institute is Accelerating Global Knowledge Sharing.

More information about the publisher can be found in the IISTE's homepage:

<http://www.iiste.org>

The IISTE is currently hosting more than 30 peer-reviewed academic journals and collaborating with academic institutions around the world. **Prospective authors of IISTE journals can find the submission instruction on the following page:**

<http://www.iiste.org/Journals/>

The IISTE editorial team promises to review and publish all the qualified submissions in a fast manner. All the journals articles are available online to the readers all over the world without financial, legal, or technical barriers other than those inseparable from gaining access to the internet itself. Printed version of the journals is also available upon request of readers and authors.

### **IISTE Knowledge Sharing Partners**

EBSCO, Index Copernicus, Ulrich's Periodicals Directory, JournalTOCS, PKP Open Archives Harvester, Bielefeld Academic Search Engine, Elektronische Zeitschriftenbibliothek EZB, Open J-Gate, OCLC WorldCat, Universe Digital Library, NewJour, Google Scholar

