

## The Real Time Hardware Design and simulation of moving message Display System Integrated with PLCC Modem

Purnendu Shekhar Pandey<sup>1\*</sup>, D .S Chauhan<sup>2</sup> ,Rajesh Singh<sup>3</sup>

1. THDC Institute of hydropower Engineering & Technology, Tehri, INDIA
  2. Vice chancellor of Utrakhand Technical University, Dehradun, INDIA
  2. College of Engineering Studies , University of petroleum and Energy studies, Dehradun, INDIA
- \*[purnendu12345@gmail.com](mailto:purnendu12345@gmail.com)

### Abstract

This paper serves as a general and technical orientation on the one of application of "Power line Carrier (PLC) Communication Systems" with scrolling message on LED/LCD with keyboard facility in real time with the presentation of a widespread and detailed analysis on the standards, characteristics, technologies, products and development associated and currently being deployed in the PLC communication systems. Since the developments and research on the subject had been relatively new in India and information scattered, the lack of collective information had been the primary Initiative behind this research. Power Line Carrier (PLC) is still widely used to provide real-time communications for protection of high voltage transmission lines. This PLCC module provides bi-directional half-duplex communication over the mains of any voltage up to (220-250)V AC and for frequency 50 Hz or 60 Hz. Usually modules is in receiving mode all the time attending to incoming communication on the power line. This application gives serial data to transmit on its RX-IN pin, it switches over to transmit and transmits the data through power line. Once transmit process is complete it switches back to receive mode. During transmission of data by Red LED indicates user that data is transmitting. At the receiving end receipt data indicated by Green LED which is on TX out pin itself. Data communication of the modules is clear to user's data terminals and protocol self-determining; as a result, multiple units can be connected to the mains without affecting the operation of the others. In this we can connect the PLC modem to the Atmega 16 controller and then program it and simulated with ISP connector and then at last connect PLC system to the AC power plug.

**Keywords :** PLCC Modem ,LED Panels, Keyboard decoder

### 1. Introduction

In order to be able to reach the end users for the provision of information, the popular technologies currently being used include telephone wires, Ethernet cabling, fibre optic, wireless and satellite technologies.

The advantage of using PLCC modem to send a real time data to the display system, it is very low cost, this modem is made by Sunrom technologies just before one year ,This will send the data in real time to the LED/LCD display systems which will scroll the message .We can use this as a college automation .

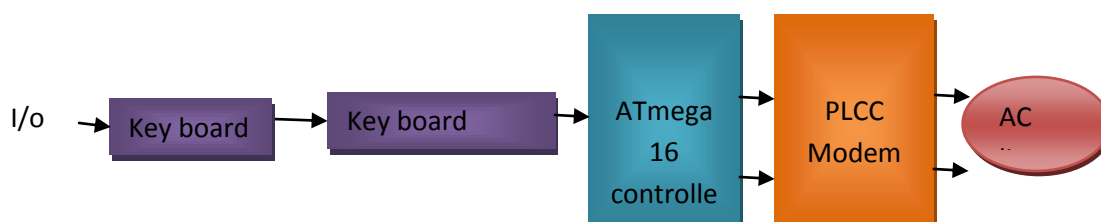

Figure1: block diagram of transmitting System

Figure 1 shows that how we are sending the data through the keyboard via controller and then PLCC modem. It is having very low power consumption device. This modem having the main features and they are:

- Transmit and Receive serial data at 9600 bps
- Data Tx/Rx LEDs
- Powered from 5V
- Low Cost & Simple to use
- Built in Error Checking
- Direct interface with microcontroller UART Txd, Rxd Pins

We used the modem (sunroom-1187) is based on much reduction in term of error data reception, in this Transmission is based on byte by byte basis. Once you give one byte to module for transmission, you will have to wait at least 500ms before a new byte is given to module again since the module waits for zero crossing of AC mains to transfer a bit. For AC 50Hz system the zero crossing of AC signals happens every 10ms and modem needs 50 zero crossings to transmit one byte with error checking data.

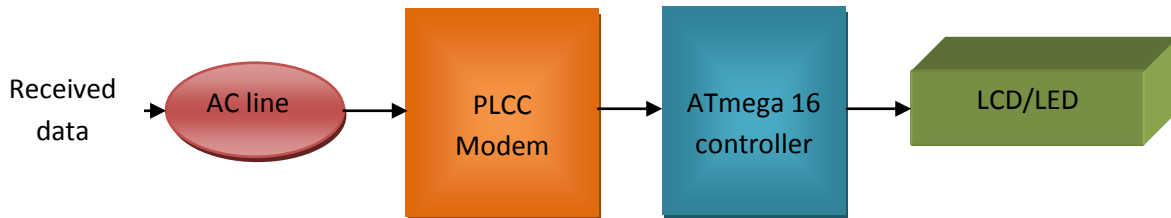

Figure 2: Receiving system of the Module

**2. Hardware development:**

The Hardware implementation deals in drawing the schematic on the plan paper according to the application, testing the schematic design over the breadboard using the various IC's to find if the design meets the objective, carrying out the PCB layout of the schematic tested on breadboard, finally preparing the board and testing the designed hardware. Hardware development of scrolling message display on led with PLCC modem is divided into two parts.

**2.1 Transmitter of the PLCC modem**

Transmitter of the system shows how we sending the character via PLCC modem to others end of the environment of same transformer .Figure 3 shows the how exactly this transmitter system works.

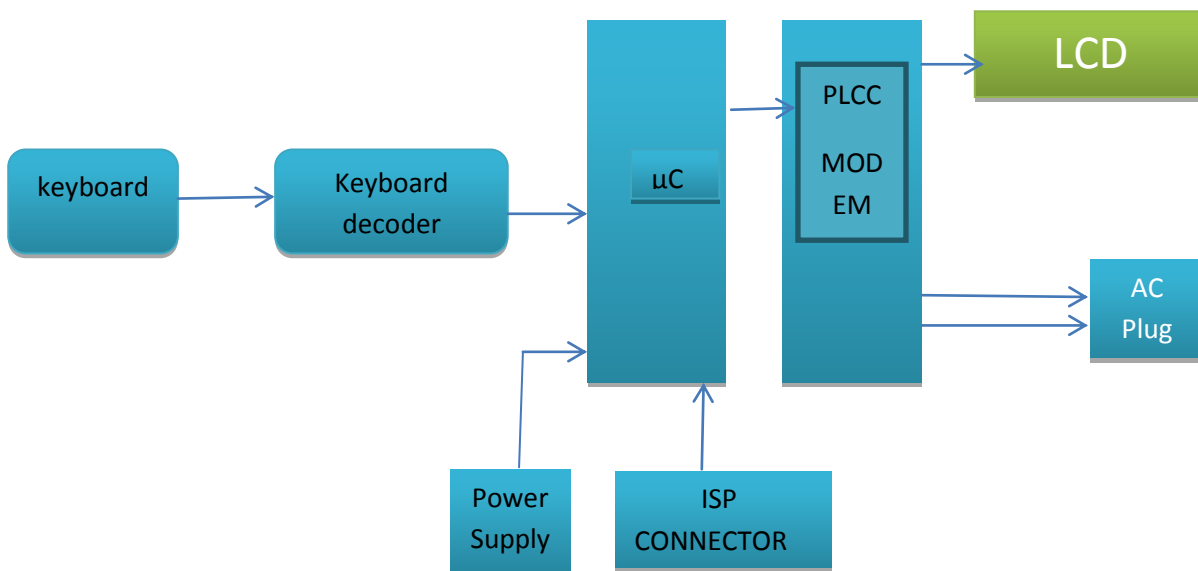

Figure 3. Block diagram of transmitting system

The components of the transmitter system are:

**2.1.1 Power supply modules**-This module is basically designed to achieved 5V, 500mA.This consists of a transformer which is used to step down the AC voltage,IN4007 diodes used to form a bridge rectifier to convert AC to DC , capacitor 1000uF which used as a filter circuit ,7805 regulator to obtain a 5V at the output of the regulator ,330 ohm resistance, LED as indicator.

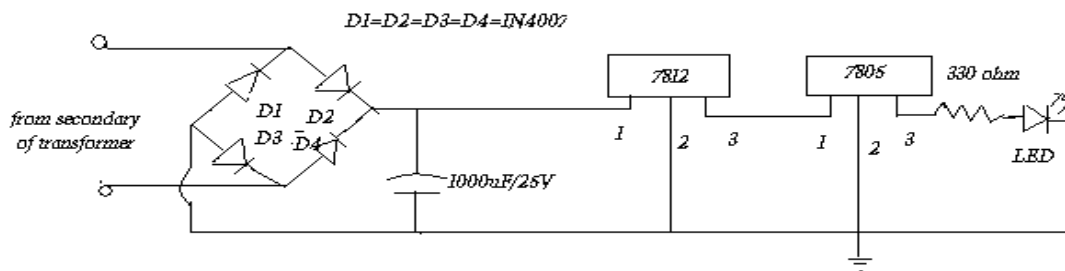

Figure 4. diagram of supply section

**2.1.2 Embedded microcontroller**-There is a whole wide range of microcontroller available in the market. But this particular project is developed using AVR series of microcontroller (ATMEGA16) because of its inbuilt ADC port and its variable frequency. ATmega16 is a low-power CMOS 8-bit microcontroller based on the AVR RISC architecture. By executing powerful instructions in a single clock cycle, the ATmega16 achieves throughputs approaching 1 MIPS per MHz, allowing the system designed to optimize power consumption versus processing speed. Further it also minimizes the cost of this personal area network.

**2.1.3 Display module**-The LCD(liquid crystal display) unit receives character codes (8 bits per character) from a microprocessor or microcomputer, latches the codes to its display data RAM (80-byte) DD RAM for storing 80 characters, transforms each character code into a 5 ´ 7 dot-matrix character pattern, and displays the characters on its LCD screen.

We are 16\*2 LCD's which have 16 columns and 2 rows with 16 hardware pins connected as pin 1,3 and 16 are connected to ground, pin 2 and 15 are connected to +5v pin 3 ,4,5 are RS ,RW and enable respectively enable pin is always low . Data pins of LCD are 11,12,13,14 which are used for 4 bit parallel communication

**2.1.4 Transmitting Module (PLCC Modem):** We used here modem for power line carrier communication made by sunroom technologies ,the model number 1187 .Power line modem is useful to send and receive serial data over existing AC mains power lines of the building. It has high immunity to electrical noise persistence in the power line and built in error checking so it never gives out corrupt data. The modem is in form of a ready to use circuit module, which is capable of providing 9600 baud rate low rate bi-directional data communication. Due to its small size it can be integrated into and become part of the user's power line data communication system. Its has main features as Transmit and Receive serial data at 9600 bps, DataTx/Rx LEDs, Powered from 5V, Low Cost & Simple to use Built in Error Checking, Direct interface with, microcontroller UART Txd/, Rxd pins.

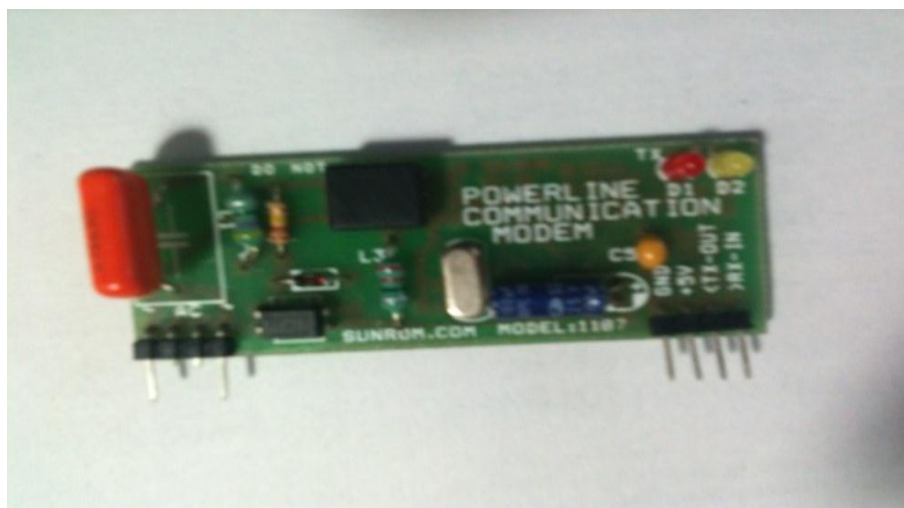

Figure 6. View of PLCC Modem

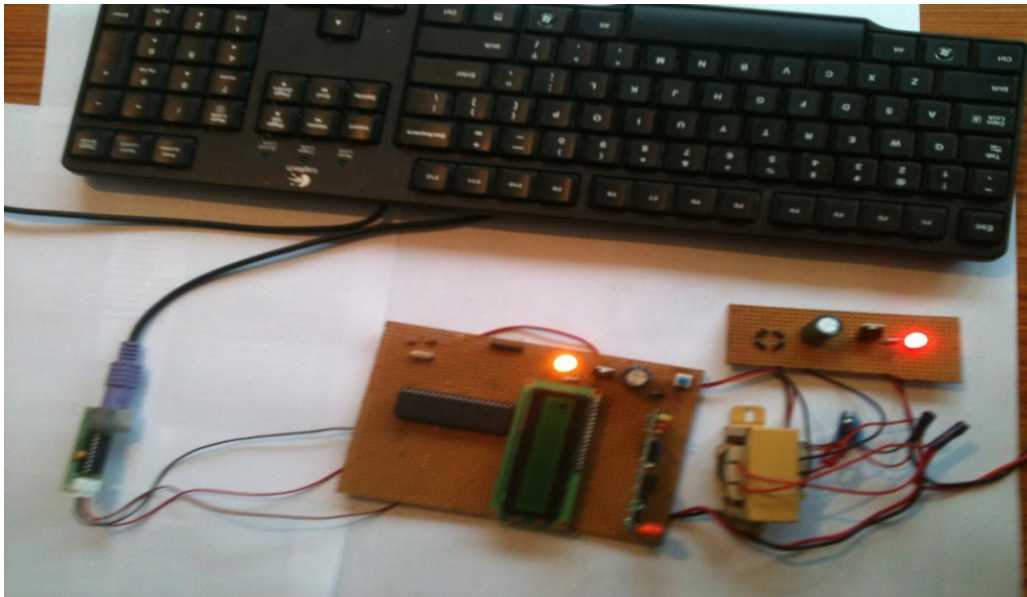

Figure 7. Hardware View of the transmitter System

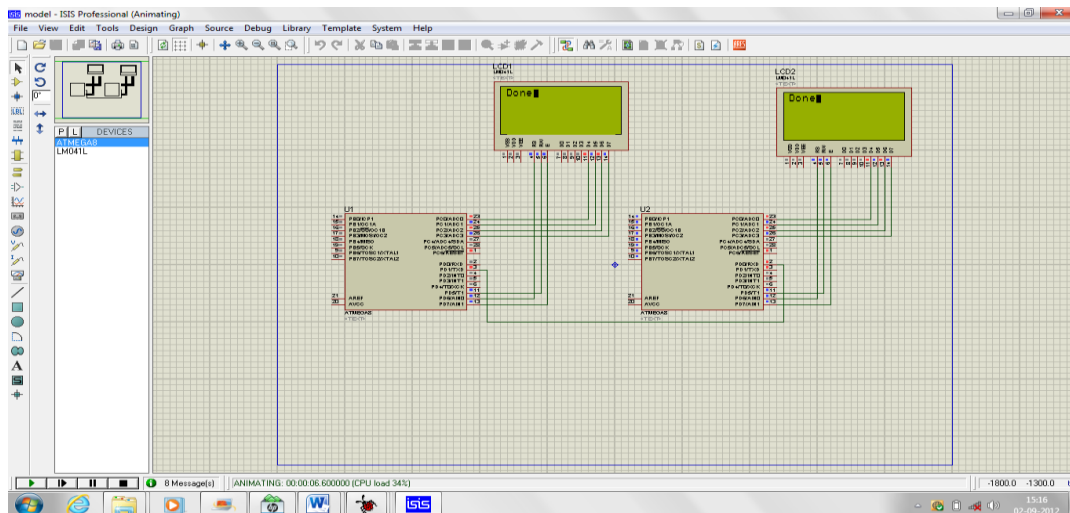

Figure8. Simulation model of transmitting using Proteus trial software

**2.2 Receiving System design**—Receiving system shown below the figure 9, the data is coming from the other end of the AC source and it is going to the Rx pin of PLCC modem and then through Tx it will go to the Rx of the controller and the display on the LED panel .

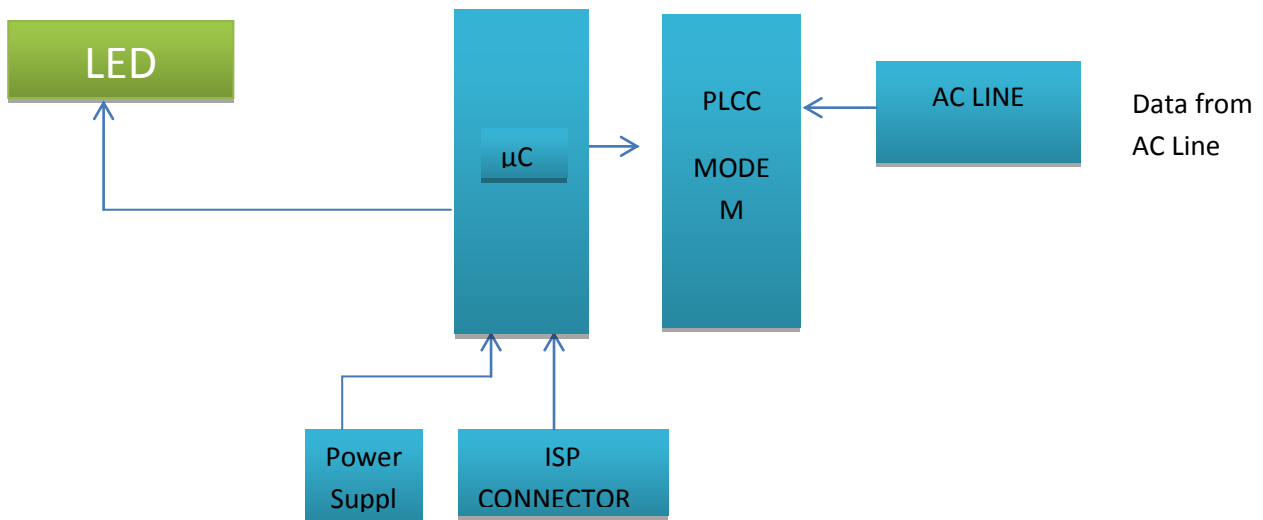

Figure9. Block diagram Receiving Section

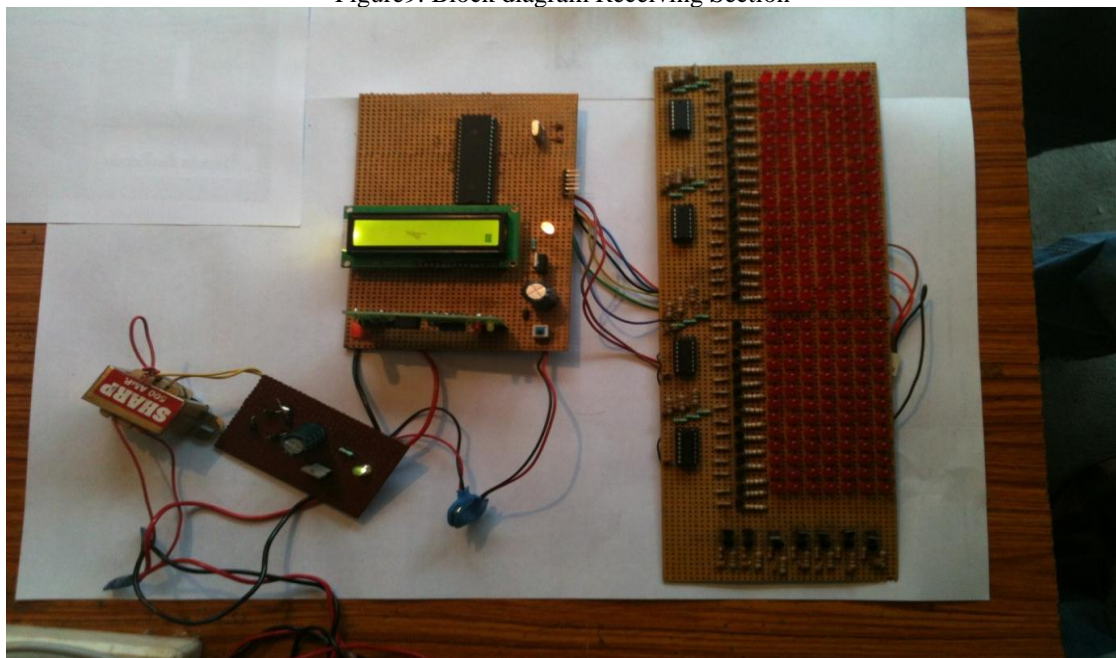

Figure 10. Hardware view of the Receiving end of the System .

The hardware of this system can be developed using following components:

**2.2.1 Power supply unit**-It is same as describe described above.

**2.2.2 PLCC module (Receiving System)** - Same as transmitting module.

**2.2.3 Embedded Microcontroller:** Same as transmitting module.

**2.2.4 Display System:** At the receiver side we placed the LED panel, this panel we are connecting to the controller by the help of shift register, High power LEDs are very costly, and so in this project we will use miniature type of LED's. Basically the standard RED colour LED requires 2-3V to ON. But to glow the LED's brightly enough, it require 20mA current to flow.



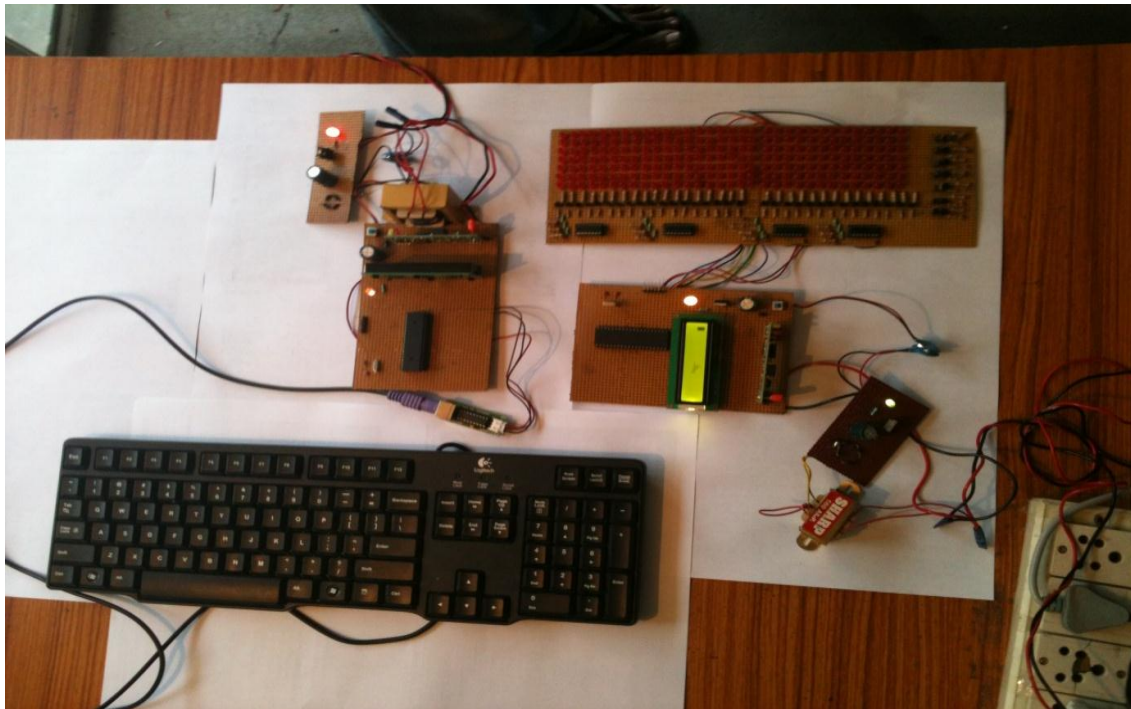

Figure 11 Overall views the System

### 3. Software Development:

Microcontroller, when it is used to operate as a wireless network involves following steps:

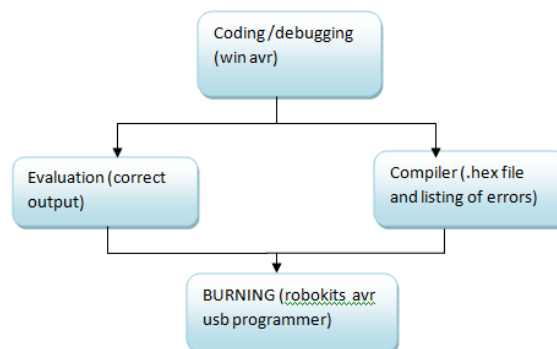

Figure12. Steps for software development

**3.1. Coding / Debugging-** Coding or debugging is one in a high-level language (such as c or java). Compiler for a high level language helps to reduce production time. To program the microcontrollers WinAVR was used using C language. The source code has been commented to facilitate any occasional future improvement and maintenance. Win AVR is a suite of executable, open source software development tools for the Atmel AVR series of RISC microprocessors hosted on the Windows platform. It includes the GNU GCC compiler for C and C++. Win AVR contains all the tools for developing on the AVR. This includes AVR-gcc (compiler), AVR-gdb (debugger) etc.

**3.2 Compiling-** After compiling the program, it is converted to machine level language in the form of 0's and 1's. This file is called as the Hex file and is saved with the extension (.Hex). The compiler also generates errors in the program which should be removed for proper execution of the program.

**3.3 Burning-** Burning the machine language (hex) file into the microcontroller's program memory is achieved with a dedicated programmer, which attaches to a PC's peripheral. PC's serial port has been used for the purpose. For this purpose Ponyprog programmer was used to burn the machine language file into the microcontroller's program memory. Ponyprog is serial device programmer software with a user-friendly GUI framework available for Windows95/98/ME/NT/2000/XP and Intel Linux. Its purpose is reading and writing every serial device. It supports I<sup>2</sup>C Bus, Micro wire, SPI EEPROM, and the Atmel AVR and Microchip PIC microcontroller. The microcontrollers were

programmed in approximately two seconds with a high speed-programming mode. The program memory, which is of Flash type, has, just like the EEPROM, a limited lifespan. On AVR microcontroller family it may be reprogrammed up to a thousand times without any risk of data corruption Atmega16 Programmer (ISP) which is used to burn the program into AVR microcontrollers.

**3.4 Evaluation**-If the system performs as desired by the user and performs all the tasks efficiently and effectively the software development phase is over and the project is ready to be installed in any of the industrial sites as a personal area network. If not, the entire process is repeated again to rectify the errors. One of the difficulties of programming microcontrollers is the limited amount of resources the programmer has to deal with. In PCs resources such as RAM and processing speed are basically limitless when compared to microcontrollers. In contrast to a PC, the code on microcontrollers should be as low on resources as possible, but being cost effective and power efficient makes it a better option.

In the programming of the proposed system is used the following .c and .h file

**3.5 lcd.c** -This c file contains the code for control of functionality of the attached LCD module. The code controls the initialization of the LCD, data writing on the LCD, and also the movement, characteristics and location of the cursor.

The module developed by the help of AVR studio and Proteus software. Proteus VSM can be installed in general purpose computer rooms anywhere on campus. The controller are programmed by the AVRDUDE. The software is written in C language and compiled using the open source compiler avr-gcc. For project management AVR studio was used .

**3.6 lcd.h**- This header file contains all the constant variable values and names of the subroutines used by various files used in the software. It clearly indicates which variable can be used as a global variable and which of the subroutines can be used across the software files.

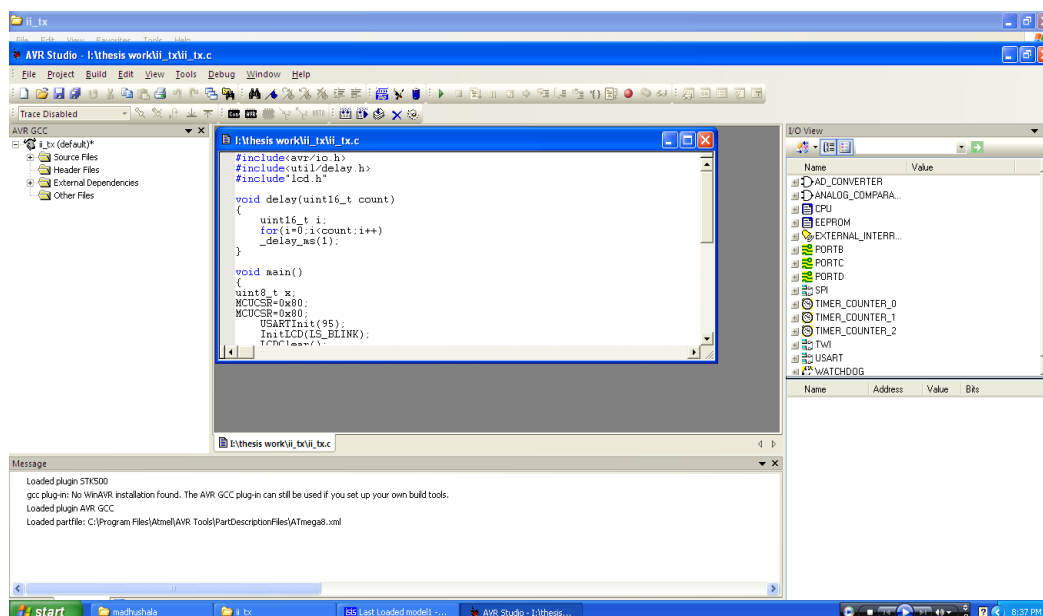

Figure 13 AVR Studio screen for the transmitter program

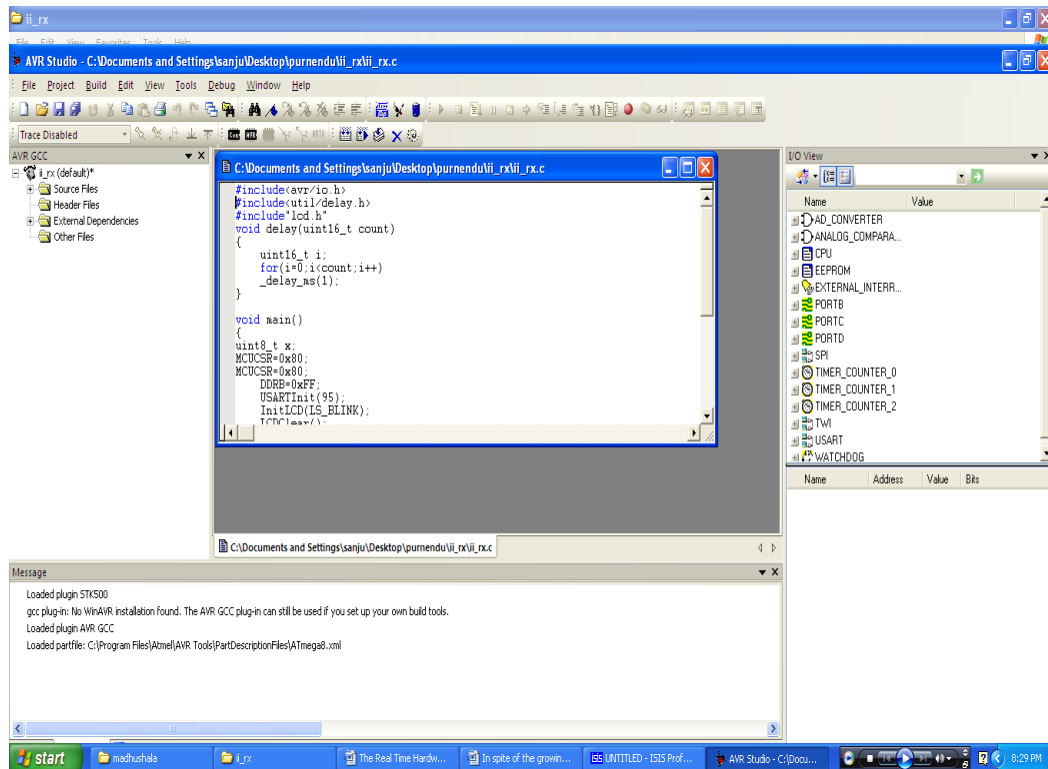

Figure 14 AVR Studio screen for the receiver program

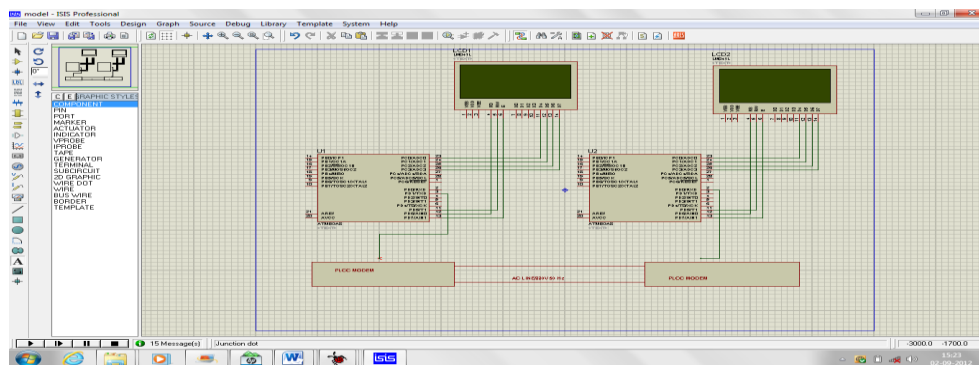

Figure15 Overall simulation model for the transmitter & Receiver by Proteus trial Version

**4. Conclusion and Future Scope:** This Hardware Design and simulation of moving message Display System Integrated with PLCC Modem is very useful at the building where our network are weak, as well as this is very low cost and less power consumptions device and it is having very low module dimension 66 x 44 mm .The future scope of the this system we can connect this module with PIC controller and also integrate with other applications. If we will use this system as in college campus or in an office we can use this in very smooth manner on a single phase AC exiting power line.

**References:**

- 1.M. Hafidzuddin Mazlan, Fatimah Mohamad,Rozeha A.Rashid, M. Adib Sarijari,M. Rozaini A. Rahim“Real-time Communication Routing Protocol for Home Automation via Power Line” Proceedings of 2008 Student Conference on Research and Development (SCOReD 2008),26-27 Nov. 2008, Johor, Malaysia
2. P K Dalela1,M V S N Prasad , Anand Mohan “ A New Concept Of Digital Power Line Carrier Communication For Rural Applications”
3. B. A. Mork, Member, IEEE, D. Ishchenko, Member, IEEE, X. Wang, A.D. Yerrabelli, R.P. Quest, C.P. Kinne “Power Line Carrier Communications System Modeling”



4 E. Mainardi, S. Banzi, M. Bonfè, S. Beghelli "A low-cost Home Automation System based on Power-Line Communication Links" 22nd International Symposium on Automation and Robotics in Construction ISARC 2005 - September 11-14, 2005, Ferrara (Italy)

5. P.Malathi and P.T.Vanathi "Power Line Communication using OFDM and OGA" *ECE Dept., PSG College of Tech, Coimbatore-04, India*. AIML Journal, Volume (7), Issue (1), June, 2007, ICGST.

**Mr. Purnendu Shekhar Pandey-** Mr .Purnendu Shekhar Pandey is a member of UACEE and has an expertise in creating sensory network in real time hardware. He is pursuing M.Tech in Digital Communication from UTU Dehradun, India. He is currently into research with many organizations. He has many research papers in renowned journals/ international conferences .He is currently working in Electronics department of THDC IHET Government College in Tehri Gharwal, Uttarakhand, INDIA.

**Prof.(Dr.) D.S.Chauhan** –Prof .D.S.Chauhan is the member of IEEE, ACM, SIAM. He did his post-doctoral work at Goddard space Flight Centre, Greenbelf Maryland and his PH.D from IIT/Delhi India in Electrical Engineering field. He has been member, NBA-executive AICTE, NABL-DST executive and member, National experts Committee for IIT-NIT research grants. . He is also author of several books and published around 150 research papers in international journals and international conferences. He is currently working as Vice Chancellor of Uttrakhand Technical University, Dehradun India.

**Dr. Rajesh Singh-** Dr. Rajesh Singh is a member of IEEE and has many research papers in renowned journals/ international conferences. He has an expertise in wireless personal area network and designing real time hardware systems based on the same. He is currently working with University of Petroleum & Energy Studies, Dehradun as a Head in Robotics institute.

This academic article was published by The International Institute for Science, Technology and Education (IISTE). The IISTE is a pioneer in the Open Access Publishing service based in the U.S. and Europe. The aim of the institute is Accelerating Global Knowledge Sharing.

More information about the publisher can be found in the IISTE's homepage:

<http://www.iiste.org>

## CALL FOR PAPERS

The IISTE is currently hosting more than 30 peer-reviewed academic journals and collaborating with academic institutions around the world. There's no deadline for submission. **Prospective authors of IISTE journals can find the submission instruction on the following page:** <http://www.iiste.org/Journals/>

The IISTE editorial team promises to review and publish all the qualified submissions in a **fast** manner. All the journals articles are available online to the readers all over the world without financial, legal, or technical barriers other than those inseparable from gaining access to the internet itself. Printed version of the journals is also available upon request of readers and authors.

## IISTE Knowledge Sharing Partners

EBSCO, Index Copernicus, Ulrich's Periodicals Directory, JournalTOCS, PKP Open Archives Harvester, Bielefeld Academic Search Engine, Elektronische Zeitschriftenbibliothek EZB, Open J-Gate, OCLC WorldCat, Universe Digital Library, NewJour, Google Scholar

