

# Studying Electrochemically Activated NaCl Solutions of Anolyte and Catholyte by Methods of Non-Equilibrium Energy Spectrum (NES) and Differential Non-Equilibrium Energy Spectrum (DNES)

Ignat Ignatov<sup>1\*</sup> Oleg Mosin<sup>2</sup> Georgi Gluhchev<sup>3</sup> Stoil Karadzhov<sup>4</sup> Georgi Miloshev<sup>5</sup> Nikolay Ivanov<sup>6</sup>

1. DSc, Professor, Scientific Research Center of Medical Biophysics (SRCMB),

N. Kopernik Street, 32, Sofia 1111, Bulgaria

2. PhD (Chemistry), Biotechnology Department, Moscow State University of Applied Biotechnology,

Talalikhina Street, 33, Moscow 109316, Russian Federation

3. PhD, Assoc. Professor; Institute of Information and Communication Technologies, Bulgarian Academy of Science (BAS), Acad. G. Bonchev Street, bl. 2, Sofia 1113, Bulgaria

4. PhD, Assoc. Professor, Institute of Molecular Biology, Bulgarian Academy of Science (BAS), Acad. G. Bonchev Street, bl. 21, Sofia 1113, Bulgaria

5. DSc., Professor, Bulgarian Association of Activated Water, Kutuzov blvd, 39, 1619 Sofia, Bulgaria

6. Dipl. Eng, Assis. Professor, Institute of Information and Communication Technologies, Bulgarian Academy of Science (BAS)

\* E-mail of the corresponding author: [mbioph@dir.bg](mailto:mbioph@dir.bg)

## Abstract

The electrochemical treatment of water with using the electric current is a promising modern approach in the water disinfection technique, resulting in obtaining the electrochemically activated water solutions (catholyte/anolyte) carrying new physical-chemical properties stipulated by changing of the electrochemical characteristics of water as ORP,  $E_h$ , pH. The process of electrochemical water treatment includes several electrochemical processes associated with the transfer in a constant electric field the electrons, ions and other charged particles (electrolysis, electrophoresis, electroflotation, electrocoagulation), the main of which is the electrolysis of water. This article deals with the review of the basic physical-chemical processes underlying the electrolysis of water and preparation of electrochemically activated NaCl solutions (catholyte/anolyte) and studying their physical-chemical properties. In order to provide additional data about the distribution of H<sub>2</sub>O molecules according to the energies of hydrogen bonds in the electrochemically activated water solutions, the non-equilibrium energy spectrum (NES) and differential non-equilibrium energy spectrum (DNES) of the anolyte and the catholyte were measured as a result of which were established the basis for evaluation of the mathematical model explaining the behavior of the anolyte and the catholyte regarding the distribution of H<sub>2</sub>O molecules to the energies of hydrogen bonds. The local maximum for catholyte in the NES-spectrum was at -0.1285 eV, for anolyte – at -0.1227 eV and for the control sample of deionized water – at -0,1245 eV. The calculations of  $\Delta E_{H...O}$  for catholyte with using the DNES method compiles (-0.004±0.0011 eV) and for anolyte (+1.8±0.0011 eV). The average energy of hydrogen bonds between H<sub>2</sub>O molecules was measured by the DNES method to be compiled at -0.1067±0.0011 eV.

**Key words:** electrochemical treatment of water, anolyte, catholyte, electrolysis, NES, DNES.

## 1. Introduction

The phenomenon of electrochemical activation of water (EAW) is a set of electrochemical and electrical processes occur in water in the electric double layer (EDL) type of electrodes (anode and cathode) with non-equilibrium electric charge transfer through EDL by electrons under the intensive dispersion in water the gaseous products of electrochemical reactions (Bahir *et al.*, 1983). In 1985 EAW was officially recognized as a new class of physical and chemical phenomena.

As a result of the treatment of water by a constant electric current at electric potentials equal to or greater than the decomposition potential of water (1.25 V), water goes into a metastable state, accompanied by electrochemical processes and characterized by the abnormal activity levels of electrons, the redox potential, and other physical-chemical parameters (pH,  $E_h$ , ORP) (Kirpichnikov *et al.*, 1986; Aider *et al.*, 2012).

During the EAW occur four main processes:

- 1) Electrolytical decomposition of water by electrolysis on account of redox reactions on the electrodes due to the external electric field;
- 2) Electrophoresis – the movement in the electric field of a positively charged particles and ions toward the cathode and negatively charged particles and ions toward the anode;
- 3) Electroflotation – the gas formation and flocculation of aggregates consisting of fine-dispersed gas bubbles ( $H_2$  at the cathode and  $O_2$  at the anode) and suspended solids in water;
- 4) Electrocoagulation – the formation of colloidal aggregates of particles of deposited disperse phase through a process of anode dissolution of the metal and the formation of metal cations  $Al^{3+}$ ,  $Fe^{2+}$ ,  $Fe^{3+}$  under the influence of electric field.

The electrochemical processes, which occur at the passage of the direct electric current through the water volume, are accompanied as a result of redox reactions leading to coagulation of colloids, flocculation of suspended solids and subsequent flotation (Kloss, 1988). The advantages of electrochemical water treatment is that it allows to correct the pH value and redox potential  $E_h$ , on which depends the possibility of occurrence of various chemical processes in water; increases the enzymatic activity of activated sludge in aeration tanks; reduces the resistivity and improves coagulation and sedimentation of organic sediments from water.

The purpose of this research was the investigation of the process of electrolysis of water, as well as the properties of the electrochemically activated water solutions – the anolyte and catholyte.

## 2. Material and Methods

The experiments were conducted with the diaphragm electrolysis apparatus “Wasserionisierer Hybrid PWI 2100”, equipped with four titanium electrodes coated with platinum. The voltage of the electric power supply – 220 V, the frequency of the electric current – 50 Hz, the power of the electric current 0.2–0.7 A; the time of electro processing – 30–40 min; the volume of the electroactivated water: anolyte – 0.3 l; catholyte – 0.9 l; power consumption – 70 Watts.

The electrolysis cell was formed by two electrodes – a positively charged anode and a negatively charged cathode connected to different poles to a DC source. Interelectrode space was filled with water, which is an electrolyte capable of conducting the electrical current, or with 0.3 % solution of chemically pure NaCl in distilled  $H_2O$ , as shown in Figure 1 below.

The anolyte had pH = 3.2 and ORP = +1070 mV; the active components –  $HClO$ ,  $Cl_2$ ,  $HCl$ ,  $HO_2^*$ ;

The catholyte had pH = 9.0 and ORP = -300...-500 mV); the active components –  $O_2$ ,  $HO_2^-$ ,  $HO_2^*$ ,  $H_2O_2$ ,  $H^+$ ,  $OH^-$ .

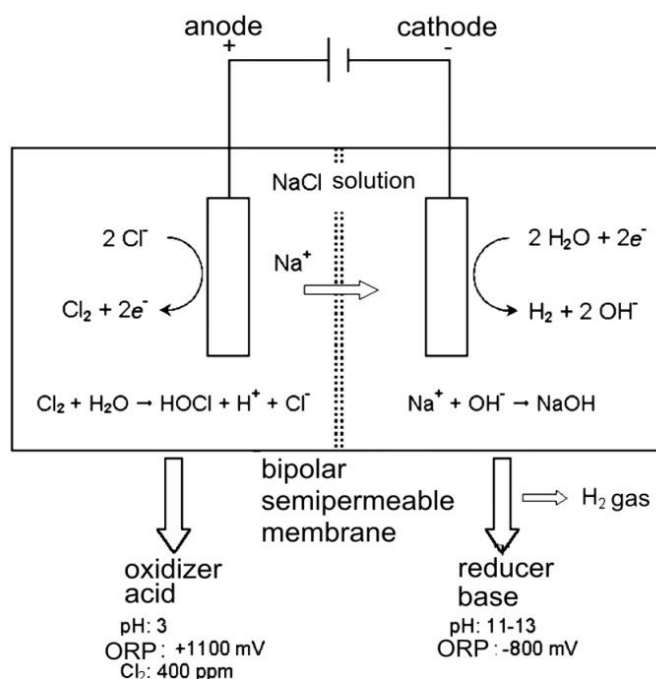

Figure 1: The diaphragm electrolysis method for the preparation of acid (anolyte) and alkali (catholyte) solutions through the electrochemical activation of NaCl

NES, and DNES methods were used for the estimation of energy of hydrogen bonds of the anolyte, the catholyte and deionized water in order to make a supposition about the spectrum peculiarities. The device measures the angle of evaporation of water drops from 72° to 0°. As the main estimation criterion was used the average energy ( $\Delta E_{H...O}$ ) of hydrogen O...H-bonds between H<sub>2</sub>O molecules in water's samples. The spectrum of water was measured in the range of energy of hydrogen bonds at 0.08–0.387 eV or  $\lambda = 8.9$ –13.8  $\mu\text{m}$  with using a specially designed computer program.

### 3. Results and Discussion

#### 3.1 Electrolysis of water

The main stage of electrochemical treatment of water is the electrolysis of water or aqueous solutions with low mineralization as aqueous solutions of 0.5–1.0 % NaCl (Morita *et al.*, 2000), which occurs in the electrolysis cell, consisting of the cathode and the anode separated by a special semipermeable membrane (diaphragm) which separates water to alkaline fraction – the catholyte and acidic fraction – the anolyte (Figure 1). When the passing over the electric current through water, the flow of electrons from cathode as well as the removal of electrons from water at the anode, is accompanied by series of redox reactions on the surface of the cathode and anode (Petrushanko *et al.*, 2001). As the result, new elements are formed, the system of intermolecular interactions, as well as the composition of water and the water structure are changed (Dykstra, 1999; Mosin, 2012).

The typical apparatus for electrochemical treatment of water comprises water preparation unit (1), the electrolyzer (2), the processing unit after the electrochemical treatment of water (3) (Figure 1).

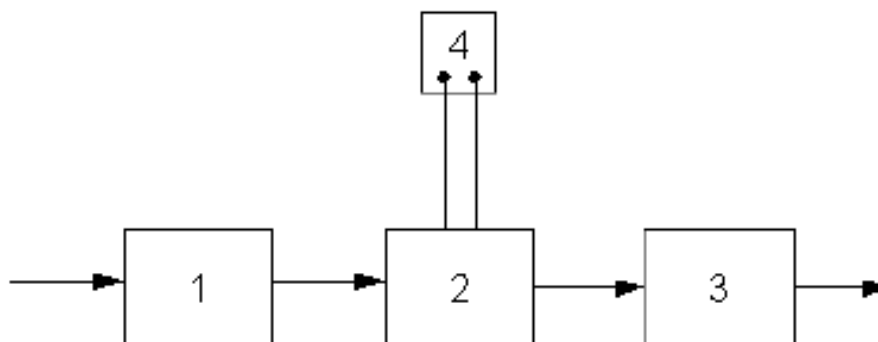

Figure 2: The apparatus for electrochemical water treatment: 1 – water treatment unit; 2 – electrolyzer; 3 – the block of post-treatment; 4 – rectifier of electric current.

The main element of the apparatus is electrolyzer consisting of one or more electrolysis cells (Figure 2). The electrolysis cell is formed by two electrodes – a positively charged anode and a negatively charged cathode connected to different poles to a DC source (Stoner, 1982). Interelectrode space is filled with water, which is an electrolyte capable of conducting electrical current. As a result it is transferred electric charges through the water – electrophoresis, i.e. migration of the polar particle charge carriers - ions for the electrode having an opposite sign. Wherein the negatively charged anions are moved toward the anode, whereas the positively charged cations are moved toward the cathode. At electrodes the charged ions lose charge and become depolarized, turning into the decay products. In addition to these charged ions, in the electrophoresis participate the polar particles with different particle sizes, including solid particles (emulsified particles, gas bubbles, etc.), but the main role in the transfer of electrochemical charges play the ions possessed by the greatest mobility.

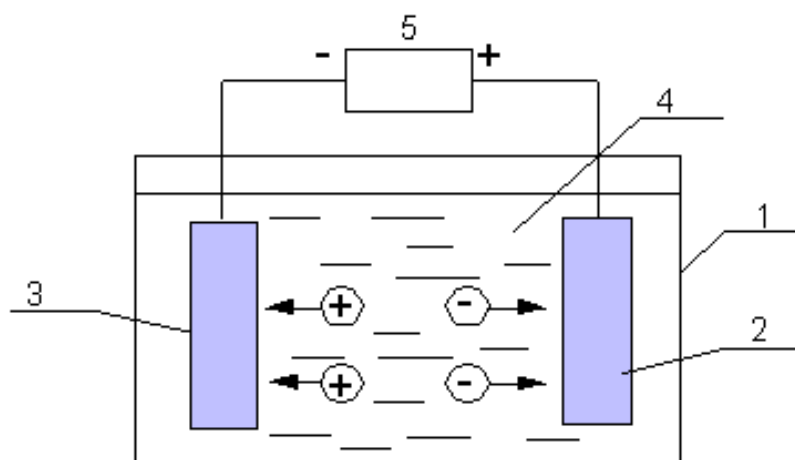
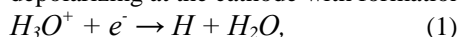
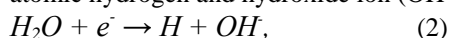

Figure 3: Scheme of the electrolysis cell: 1 – the case; 2 – anode; 3 – cathode; 4 – interelectrode space; 5 – DC power source.

The products of electrode reactions are the neutralized aqueous admixtures, gaseous hydrogen and oxygen generated during the electrolytic destruction of  $H_2O$  molecules, metal cations ( $Al^{3+}$ ,  $Fe^{2+}$ ,  $Fe^{3+}$ ) in the case of metal anodes made of aluminum and steel, and the molecular chlorine. Wherein at the cathode is generated the gaseous hydrogen, and at the anode – oxygen. Water also contains a certain amount of hydronium ions ( $H_3O^+$ ) depolarizing at the cathode with formation of the atomic hydrogen:



In an alkaline environment there occurs the disruption of  $H_2O$  molecules, accompanied by formation of the atomic hydrogen and hydroxide ion ( $OH^-$ ):



The reactive hydrogen atoms are adsorbed on the surfaces of the cathode, and after recombination are formed the molecular hydrogen  $H_2$ , released in the gaseous form:

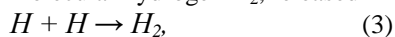

At the same time at the anode is released the atomic oxygen. In an acidic environment, this process is accompanied by the destruction of H<sub>2</sub>O molecules:

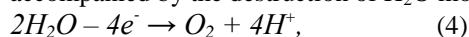

In an alkaline environment, the source of oxygen source is OH<sup>-</sup> ions, moving under the electrophoresis from the cathode to the anode:

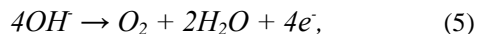

The normal redox potentials of these reactions compiles +1.23 V and +0.403 V, respectively, but the process takes place in certain conditions of electric overload.

The cathodes are made of metals that require high electrical voltage (lead, cadmium), allow to generate the reactive free radicals as Cl<sup>\*</sup>, O<sup>\*</sup>, OH<sup>\*</sup>, HO<sub>2</sub><sup>\*</sup>, which react chemically with other radicals and ions.

In bulk oxidative processes a special role plays products of electrolysis of water – oxygen (O<sub>2</sub>), hydrogen peroxide (H<sub>2</sub>O<sub>2</sub>) and hydrochlorine acid (HClO). During the electrolysis, an extremely reactive compound formed – H<sub>2</sub>O<sub>2</sub>, the formation of which occurs due to the hydroxyl radicals (OH<sup>\*</sup>), which are the products of the discharge of hydroxyl ions (OH<sup>-</sup>) at the anode:

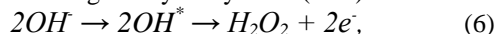

where OH<sup>\*</sup> – the hydroxyl radical.

The chlorine-anion is transformed to Cl<sub>2</sub>:

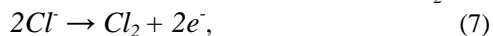

Gaseous Cl<sub>2</sub> forms highly active oxidants: Cl<sub>2</sub>O; ClO<sub>2</sub>; ClO<sup>-</sup>; HClO; Cl<sup>\*</sup>; HO<sub>2</sub><sup>\*</sup>. The parameters of pH, the redox potential, ORP and the electrical conductivity of the anolyte/catholyte depend on different factors including the ratio of water volumes in the two electric chambers, the material of electrodes, NaCl concentration, the temperature, electric voltage and processing time (Bahir, 1992).

The electrolysis cell can be regarded as a generator of the above mentioned products, some of them, entering into the chemical interaction with each other and water impurities in the interelectrode space, providing additional chemical treatment of water (electrophoresis, electroflotation, electrocoagulation) (Hsu, 2005). These secondary processes do not occur on the electrode surface, but in the bulk water. Therefore, in contrast to the electrode processes they are indicated as the volume processes. They generally are initiated with increasing the temperature of water during the electrolysis process and with increasing the pH value.

There are distinguished the cathodic and anodic oxidation. When the cathodic oxidation the organic molecules adsorbed on cathodes, accepting free electrons and reduced. The reduction process usually takes place in one step:

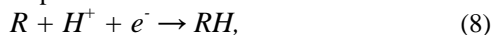

where R – the organic compound; RH – the hydrated form of a compound.

In other cases, the cathodic reduction takes place in two stages: at the first stage (9) the organic molecule is converted into an anion, in the second (10) – the hydrated anion interacts with the proton of H<sub>2</sub>O water:

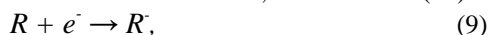

The cathodes made of materials that require high electrical voltage (lead, cadmium), allow for large amounts of electricity to generate the reactive free radicals – particles having on the outer orbits of atoms or molecules free unpaired electrons (Cl<sup>\*</sup>, O<sup>\*</sup>, OH<sup>\*</sup>, HO<sub>2</sub><sup>\*</sup>). The latter circumstance makes the free radicals the reactivity, i.e. to react chemically with other radicals and ions.

At the anodic oxidation the organic molecules, adsorbed on the anode, give up electrons to simultaneous or prior hydration:

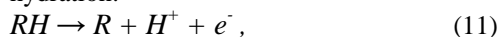

The anodic oxidation of organic compounds often results in the formation of free radicals, which further transformations is defined by their reactivity. Anodic oxidation processes are multistage and proceed with the formation of intermediate products. Anodic oxidation lowers the chemical resistance of organic compounds and facilitates their subsequent destruction in volume processes.

The rate of the anodic oxidation depends on the temperature and the pH value. Often in the process of oxidation of organic compounds are formed intermediates, which differ from the original compounds by the resistance to further transformations and indicators of toxicity.

The source of active chlorine and its oxygen-containing compounds are chlorides generated in the electrolyser, and NaCl, which is added into the electrochemically treated water before the electrolysis. As a result of the anodic oxidation of Cl<sup>-</sup> anions is generated the gaseous Cl<sub>2</sub>. Depending on the pH value Cl<sub>2</sub> is either hydrolyzed to form hypochlorous acid (HOCl), or forms hypochlorite ions (ClO<sup>-</sup>). The equilibrium of the reaction depends on the pH value; at pH = 4–5 all chlorine is present in the form of HClO, and at pH = 7 – half in the form of ClO<sup>-</sup> ion and half – in the form of HClO (Figure 4).

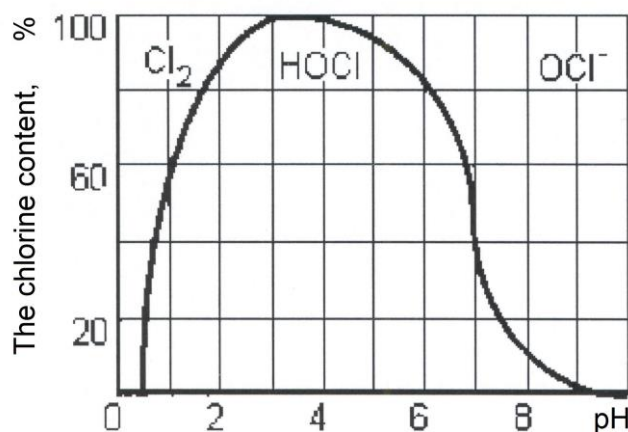
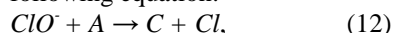

Figure 4: Content (%) of various forms of chlorine (Cl<sub>2</sub>, HOCl, OCl<sup>-</sup>) in the electrochemically activated water depending on the pH value

The mechanism of interaction between the hypochlorite ions (ClO<sup>-</sup>) with the oxidizing agent described by the following equation:



where A – the oxidizing substances; C – the oxidation product.

The electrochemical oxidation of organic compounds by hypochlorite ions (ClO<sup>-</sup>) is accompanied by an increase in the redox potential E<sub>h</sub>, indicating the predominance of oxidative processes (Bahir, 2001). The E<sub>h</sub> value growth depends on the ratio of active chlorine concentration in the interelectrode space to the content of organic impurities in water. As the purification and reducing the amount of impurities, the ratio increases, which leads to an increase of E<sub>h</sub>, but after some time the rate stabilizes.

The amount of substance reacted at the electrodes by passing a constant electric current through the Faraday's law, is directly proportional to the current strength and the time of the electrochemical treatment:

$$G = AI_{cur}t, \quad (13)$$

where A – the electrochemical equivalent of an element (g/A·h); I<sub>cur</sub> – the amperage (A); t – the processing time (h).

The electrochemical equivalent of an element is defined by the formula:

$$A = M/26.8z, \quad (14)$$

where M – the atomic mass of the element (g); z – its valence.

The values of the electrochemical equivalents of some elements are shown in Table. 1.

Table 1: Electrochemical equivalents of some elements

Element	The electrochemical equivalent of an element, g/A·h
H <sub>2</sub>	0.0376
O <sub>2</sub>	0.289
Fe (II)	1.042
Fe (III)	0.695
Al (III)	0.336
Cr (III)	0.647
Cr (VI)	0.324
Cu (II)	1.186
Zn (II)	1.22
Cl <sub>2</sub>	1.324
Ca (II)	0.748

The actual amount of a substance, generated during the electrolysis is less than the theoretical, calculated from the formula (13) as part of the electric power is expended on heating the electrodes and water. Therefore, at calculations take into account the current efficiency  $\eta < 1$ , the value of which is determined experimentally.

The electrode processes are accompanied by an exchange of charged particles and ions between the electrodes and the electrolyte – water. For this the equilibrium must be established to provide an electric potential minimum value, which depends on the sort of the redox reaction and the water temperature at +25 °C (Table 2).

Table 2: The electrode potentials of some elements

Electrode reaction	Electric voltage [V]	Electrode reaction	Electric voltage [V]
$\text{Al} \rightarrow \text{Al}^{3+} + 3\text{e}^-$	-1.66	$\text{Cu} \rightarrow \text{Cu}^{2+} + \text{e}^-$	+0.345
$\text{Zn} \rightarrow \text{Zn}^{2+} + 2\text{e}^-$	-0.763	$4\text{OH}^- \rightarrow 2\text{H}_2\text{O} + \text{O}_2 + 4\text{e}^-$	+0.401
$\text{Fe} \rightarrow \text{Fe}^{2+} + 2\text{e}^-$	-0.44	$2\text{H}_2\text{O} \rightarrow \text{O}_2 + 4\text{H}^+ + 4\text{e}^-$	+1.23
$\text{Cd} \rightarrow \text{Cd}^{2+} + 2\text{e}^-$	-0.403	$2\text{Cl}^- \rightarrow \text{Cl}_2 + 2\text{e}^-$	+1.36
$\text{H}_2 \rightarrow 2\text{H}^+ + 2\text{e}^-$	0.0001	$\text{Cl}^- + \text{H}_2\text{O} \rightarrow \text{HClO} + \text{H}^+ + 2\text{e}^-$	+1.49

The electrical voltage generated in the electrode cell, should be sufficient to cause oxidation-reduction reactions at the electrodes. The voltage depends on the ionic composition of water, the presence of impurities in water, such as detergents, the electric current density (its power per unit area of the electrode), the electrode material, and others. Other things being equal the task of selecting the electrode material is to undergo the oxidation-reduction reactions at the electrodes, the voltage required to be minimized since it reduces the cost of electricity. Some redox reactions are competing – they occur simultaneously and mutually inhibit each others. Their flow can be regulated by changing the electric voltage in the electrolytic cell. Thus, the normal electrical potential of the reaction of formation of molecular oxygen is +0.401 V or +1.23 V; when the voltage increases to +1.36 V (the normal potential of the reaction of formation of molecular chlorine) at the anode will be allocated only oxygen, and at the further increase in capacity – both oxygen and chlorine, and the evolution of chlorine will occur with insufficient intensity. At the voltage value +5 V the oxygen evolution will be almost ceased, and the electrolytic cell will only generate chlorine.

### 3. 2. The physical-chemical properties of the catholyte and the anolyte

As a result of the cathode (catholyte) treatment water becomes alkaline: its ORP decreases, the surface tension is reduced, decreasing the amount of dissolved oxygen in water, increases the concentration of hydrogen, hydroxyl ions ( $\text{OH}^-$ ), decreases the conductivity of water, changes the structure of hydration shells of ions (Shimada *et al.*, 2000). By external characteristics the catholyte – is a soft, light, with an alkaline taste liquid, sometimes with white sediment; its pH = 10–11, ORP = -200...-800 mV.

On physical and chemical parameters the catholyte has the significantly enhanced electron-donating properties, and getting into the physiological fluids of an organism can enhance the electron-background for a few tens of millivolts (Toropkov *et al.*, 2001; Tanaka *et al.*, 1996). The catholyte reportedly has antioxidant, immunostimulating, detoxifying properties, normalizing ORP, metabolic processes (increases the ATP synthesis, modification of enzyme activity), stimulates the regeneration of tissues, increases the DNA synthesis and stimulates the growth and division of cells by increasing the mass transfer of ions and molecules across the cell membrane, improves trophic processes in tissues and blood circulation (Petrushanko & Lobyshev, 2004). It was also reported that catholyte with the redox potential at -700...-100 mV favors the development of anaerobes, whereas the anolyte with the redox potential at +200...+750 mV supports the growth of aerobes (Prilutsky & Bakhir, 1997). The antibacterial effect of the catholyte is differentiated: the bactericidal effect is appeared relative to Enterobacteriaceae, resistant to it are enterococci and the group of streptococci B, and against Gram-negative microorganisms – only the bacteriostatic effect (Leonov *et al.*, 1999).

The electrochemically activated solutions of the catholyte, depending on the strength of the transmitted electric current may be of several types:

**C** – the alkaline catholyte (pH > 9.0; ORP = -700...-820 mV), the active components – NaOH,  $\text{O}_2$ ,  $\text{HO}_2^-$ ,  $\text{HO}_2^*$ ,  $\text{OH}^-$ ,  $\text{OH}^*$ ,  $\text{HO}_2^-$ ,  $\text{O}_2$ ;

**CN** – the neutral catholyte (pH = 9.0; ORP = -300...-500 mV), the active components –  $\text{O}_2$ ,  $\text{HO}_2^-$ ,  $\text{HO}_2^*$ ,  $\text{H}_2\text{O}_2$ ,  $\text{H}^+$ ,  $\text{OH}^-$ .

As a result of the anode (anolyte) treatment water becomes acid reaction, the ORP increases slightly, the surface tension is slightly reduced, the conductivity increases, the amount of the dissolved oxygen and chlorine in water also increases, whereas the amount of hydrogen decreases (Toropkov *et al.*, 1999). The anolyte is a brownish, acid, with a characteristic odor and taste the liquid with a pH = 4–5 and ORP = +500...+1100 mV. The specific

anolyte toxicity when being administered in the stomach and applying to the skin refers to the class 4 of harmful substances according to the Russian Standard GOST 12.1.007-76, with the minimal toxicity within this class (Yahagi *et al.*, 2000; Inoue *et al.*, 1997). When being inhaled the anolyte with oxidants content of 0.02 % and total mineralization 0.25–0.35 % does not irritate the respiratory system and mucous membranes of the eyes. When introduced into the organism, the anolyte has no immunotoxic action and increased chromosomal aberrations in the bone marrow cells and other tissues, and it has no cytogenetic activity. When being heated to +50 °C the bactericidal activity of the anolyte is increased by 30–100 % (Leonov *et al.*, 1999b).

The electrochemically activated solutions of the anolyte are divided into four main types:

**A** – the acidic anolyte (pH < 5.0; ORP = +800...+1200 mV), the active components – HClO, Cl<sub>2</sub>, HCl, HO<sub>2</sub>\*;

**AN** – the neutral anolyte (pH = 6.0; ORP = +600...+900 mV), the active components – HClO, O<sub>3</sub>, HO<sup>-</sup>, HO<sub>2</sub>\*;

**ANK** – the neutral anolyte (pH = 7.7; ORP = +250...+800 mV), the active components – HClO, ClO<sup>-</sup>, HO<sub>2</sub><sup>-</sup>, H<sub>2</sub>O<sub>2</sub>, O<sub>2</sub>, Cl<sup>-</sup>, HO\*;

**ANKD** – the neutral anolyte (pH = 7.3; ORP = +700...+1100 mV), the active components – HClO, HClO<sub>2</sub>, ClO<sup>-</sup>, ClO<sub>2</sub>\*; HO<sub>2</sub>\*; H<sub>2</sub>O<sub>2</sub>, O<sub>2</sub>, O<sub>3</sub>, Cl<sup>-</sup>, HO<sup>-</sup>, O\*.

The anolyte has antibacterial, antiviral, antifungal, anti-allergic, anti-inflammatory, antiedematous and antipruritic effect, may be cytotoxic and antimetabolite action without harming the human tissue cells (Kirkpatrick, 2009). The biocide elements in the anolyte are not toxic to somatic cells, as represented by oxidants, such as those ones produced by the cells of higher organisms.

Studies on the virucidal effect of the anolyte are rare and insufficient, basically on the possibilities of applying the anolyte in the implementation of effective control of viral diseases in humans and animals and especially on particularly dangerous viral infections, as staphylococcal Enterotoxin-A (Suzuki *et al.*, 2002). One of them is the classical swine fever (CSF), prevalent in different regions of the world and inflicting heavy economic losses. It is caused by enveloped viruses belonging to the genus *Pestivirus* of the family *Flaviviridae* (Edwards, A. & Edwards, S, 2000). The resistance and inactivation of the virus of CSF virus is a subject of extensive research. Although it is less resistant to external stresses other than non-enveloped viruses, it retains its virulence for a long period of time: in frozen meat and organs – from a few months up to one year; in salted meat – up to three years; in dried body fluids and excreta – from 7 to 20 days. In rotting organs it dies for a few days and in urine and faeces – for approx. 1–2 days. In liquid fertilizer it can withstand 2 weeks at +20 °C, and over 6 weeks at +4 °C. Its thermal resistance may vary depending on the strain type, but the inactivation is dependent mostly on the medium containing the virus. Although the CSF virus loses its infectivity in cell cultures at +60 °C for 10 min, it is able to withstand at least 30 min at t = +68 °C in defibrinated blood. It is relatively stable at pH = 5–10, and the dynamic of the inactivating process below pH = 5 depends on the temperature.

According to J.A. Sands (Sands *et al.*, 1979) and U.S. Springthorpe (Springthorpe & Sattar, 1990), the effective disinfection of viruses whose infectivity is associated with the elements of the virus casing is achieved by disinfectants dissolving poly-saturated fats, fatty acids, lipids, protein and proteases. It is thought that to achieve the effective electrochemical disinfection it is necessary to irreversibly damage the RNA (Kim *et al.*, 2000).

Investigations conducted by other authors (Zinkevich *et al.*, 2000) were carried out with *E. coli*, using as a disinfectant the anolyte with the ORP equal or greater than +1100 mV and pH = 5,5, obtained via electrolysis of diluted NaCl solution on cells of a strain of *E. coli JM109*. It was demonstrated that within 5 min of influence all cells were inflated and burst. Also, it was occurred the destruction of proteins, DNA and RNA. Supposedly the anolyte enters the cells, provoking structural and functional damages on the cell's membrane.

Similar research was performed by S.V. Kumar (Kumar *et al.*, 1999) in order to evaluate the inactivation efficacy of the anolyte at pH = 2.7 and ORP = +1100 mV on *E. coli O157:H7*, *Salmonella enteritidis* and *Listeria monocytogenes*. As it was demonstrated on five strains of *E. coli E06* (milk), E08 (meat), E10 (meat), E16 (meat) and E22 (calf feces), all pathogens were significantly reduced (7.0 log CFU/ml) or fully destroyed (8.0 log CFU/ml) after 2 to 10 min inactivation by the anolyte within the temperature range from +4 °C to +23 °C. Supposedly, the low pH value of the anolyte makes sensitive the outer cell's membrane, thus facilitating HClO to enter into the cell and further destroy it. Unexpectedly, the stronger biocidal effect of the catholyte was observed when a strain of *E. coli DH5* was treated by the anolyte and catholyte, respectively.

The virucidal action of the anolyte was studied by us on cell culture and suspensions of classical swine fever (CSF) (Atanasov *et al.*, 2014; Karadzov *et al.*, 2014). After inoculating them with cell cultures, the viral presence (the presence of viral antigen) was measured using the immunoperoxidase technique. It was found that anolyte did not affect the growth of the cell culture PK-15; viral growth during the infection of a cell monolayer with a cell culture virus was affected in the greatest degree by the anolyte in 1:1 dilution and less in other dilutions; whereas the viral growth at the infection of a cell suspension with the CSF virus was affected by the anolyte in dilution 1:1 in the greatest degree, and less by other dilutions; viral growth at the infection with a virus in suspension of the cell monolayer was affected by the anolyte in all dilutions.

### 3.3. NES and DNES spectral analysis of the catholyte and the anolyte



Other method for obtaining useful information about the structural changes in water and the average energy of hydrogen bonds is the measuring of the energy spectrum of the water state. It was established experimentally that at evaporation of water droplet the contact angle  $\theta$  decreases discretely to zero, whereas the diameter of the droplet changes insignificantly (Antonov, 2005). By measuring this angle within a regular time intervals a functional dependence  $f(\theta)$  can be determined, which is designated by the spectrum of the water state (Ignatov & Mosin, 2013; Ignatov & Mosin, 2014). For practical purposes by registering the spectrum of water state it is possible to obtain information about the averaged energy of hydrogen bonds in an aqueous sample. For this purpose the model of W. Luck was used, which consider water as an associated liquid, consisted of O–H...O–H groups (Luck *et al.*, 1980). The major part of these groups is designated by the energy of hydrogen bonds ( $-E$ ), while the others are free ( $E = 0$ ). The energy distribution function  $f(E)$  is measured in electron-volts ( $eV^{-1}$ ) and may be varied under the influence of various external factors on water as temperature and pressure. For calculation of the function  $f(E)$  experimental dependence between the water surface tension measured by the wetting angle ( $\theta$ ) and the energy of hydrogen bonds ( $E$ ) is established:

$$f(E) = \frac{14,33 f(\theta)}{[1-(1+bE)^2]^2} \quad (15)$$

where  $b = 14.33 eV^{-1}$ ;  $\theta = \arccos(1 - bE)$

The energy of hydrogen bonds ( $E$ ) measured in electron-volts ( $eV$ ) is designated by the spectrum of energy distribution. This spectrum is characterized by non-equilibrium process of water droplets evaporation, thus the term “non-equilibrium energy spectrum of water” (NES) is applied.

The difference  $\Delta f(E) = f(\text{samples of water}) - f(\text{control sample of water})$

– is designated the “differential non-equilibrium energy spectrum of water” (DNES).

The DNES-spectrum measured in milielectron volts ( $0.001 eV$ ) is a measure of changes in the structure of water as a result of external factors. Figure 5 shows the characteristic NES-spectrum of deionized water made from 25 independence measurements done in a period of one year.

We studied the characteristics of NES and DNES-spectra of catholyte and anolyte solutions and distribution of local maximums in them. Also the average energy ( $\Delta E_{H...O}$ ) of hydrogen H...O-bonds among individual molecules  $H_2O$  was calculated for the catholyte and the anolyte by NES- and DNES-methods. Local maximums of catholyte and anolyte solutions in NES- and DNES-spectra are shown in Table 3. The local maximum for the catholyte in the NES-spectrum was detected at  $-0.1285 eV$ , for anolyte – at  $-0.1227 eV$ , and for the control sample of deionized water – at  $-0.1245 eV$ . The calculations of  $\Delta E_{H...O}$  for catholyte with using the DNES method compiles ( $-0.004 \pm 0.0011 eV$ ) and for anolyte ( $+1.8 \pm 0.0011 eV$ ).

It should be noted that in 1992 A. Antonov performed experiments with the impact of different types of water on tumor mice cells. It was detected a decrease in the NES-spectrum compared with the control sample of cells from healthy mice. At the same time there was a decrease of the local maximum at  $-0.1387 eV$ , or  $8.95 \mu m$ . In the DNES-spectrum the local maximum at  $8.95 \mu m$  was with the negative value. It is remarkable that for the catholyte the local maximum in the DNES-spectrum was detected with the positive value at  $133.3 eV^{-1}$ .

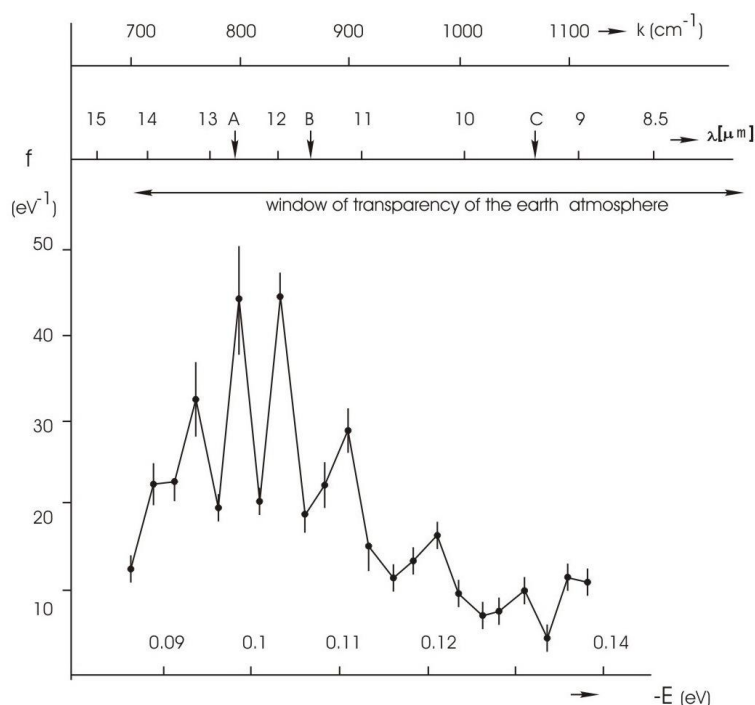

Figure 5: NES-spectrum of deionized water (chemical purity – 99.99 %; pH – 6.5–7.5; total mineralization – 200 mg/l; electric conductivity – 10  $\mu$ S/cm). The horizontal axis shows the energy of the H...O hydrogen bonds in the associates – E (eV). The vertical axis – energy distribution function – f ( $eV^{-1}$ ). k – the vibration frequency of the H–O–H atoms ( $cm^{-1}$ );  $\lambda$  – wavelength ( $\mu m$ ).

The evaluation of the possible number of hydrogen bonds as percent of H<sub>2</sub>O molecules with different values of distribution of energies for electrochemically activated catholyte and anolyte solutions is presented in Table 4. These distributions are basically connected with the restructuring of H<sub>2</sub>O molecules having the same energies. These data serves as the mathematical model explaining the behavior of the anolyte and the catholyte regarding the distribution of H<sub>2</sub>O molecules to the energies of hydrogen bonds in samples of electrochemically activated water solutions of the catholyte and the anolyte. These data testifies that not only the number of H<sub>2</sub>O molecules with different energies of hydrogen bonds changes, but also the number of hydrogen bonds, the redistribution of H<sub>2</sub>O molecules and the character of hydrogen bonding changes as well. This phenomenon may be explained by the fact that under the influence of electric field the hydrogen bonds between H<sub>2</sub>O molecules become polarized and get disrupted, therefore the cluster size may be changed to up to a few H<sub>2</sub>O molecules. However, these are our preliminary judgments, based on the character of NES and DNES-spectra and distribution of local maximums and minimums in spectra that will be continued in future studies.

Table 3: Local maximums of catholyte and anolyte solutions in NES- and DNES-spectra

-E(eV) x-axis	Catholyte	Anolyte y-axis ( $eV^{-1}$ )	Control sample y-axis ( $eV^{-1}$ )	DNES Catholyte	DNES Anolyte	-E(eV) x-axis	Catholyte y-axis ( $eV^{-1}$ )	Anolyte y-axis ( $eV^{-1}$ )	Control Sample y-axis ( $eV^{-1}$ )	DNES Catholyte y-axis ( $eV^{-1}$ )	DNES Anolyte y-axis ( $eV^{-1}$ )
0.0937	0	0	0	0	0	0.1187	0	66.7	66.7	-66.7	0
0.0962	0	0	0	0	0	0.1212	66.7	0	0	66.7	0
0.0987	0	0	0	0	0	0.1237	0	0	0	0	0
0.1012	66.7	66.7	33.3	33.4	33.4	0.1262	0	0	66.7	-66.7	-66.7
0.1037	0	0	33.3	-33.3	-33.3	0.1287	0	0	66.7	-66.7	-66.7
0.1062	0	0	0	0	0	0.1312	33.3	100	33.3	0	66.7
0.1087	0	0	0	0	0	0.1337	33.3	33.3	33.3	0	0
0.1112	0	0	0	0	0	0.1362	0	0	0	0	0
0.1137	0	66.7	66.7	-66.7	0	0.1387	200	66.7	66.7	133.3	0
0.1162	0	0	0	0	0	-	-	-	-	-	-

Table 4: Energy distribution of alkaline (catholyte) and acid (anolyte) solutions in electrochemical activation of sodium chloride

-E(eV) x-axis	Catholyte y-axis (%((-Evalue)/ (-Etotal value)	Anolyte y-axis (%((-Evalue)/ (-Etotal value)	-E(eV) x-axis (%((-Evalue)/ (-Etotal value)	Catholyte y-axis (%((-Evalue)/ (-Etotal value)	Anolyte y-axis (%((-Evalue)/ (-Etotal value)
0.0937	0	0	0.1187	0	16.7
0.0962	0	0	0.1212	16.7	0
0.0987	0	0	0.1237	0	0
0.1012	16.7	16.7	0.1262	0	0
0.1037	0	0	0.1287	0	0
0.1062	0	0	0.1312	8.4	24.8
0.1087	0	0	0.1337	8.4	8.4
0.1112	0	0	0.1362	0	0
0.1137	0	16.7	0.1387	49.8	16.7
0.1162	0	0	–	–	–

#### 4. Conclusion

The electrochemical water treatment has several advantages compared to alternative chemical methods for disinfection of water. These advantages are the efficiency, stability, controllability and convenient automatic control of the electrolysis processes, as well as simplicity of the construction scheme. The devices for the electrochemical water treatment are compact, have a high level of reliability, easy operation and demand, and may be fully automated. In multi-stage schemes to improve water quality and its disinfection the electrochemical treatment can conveniently be combined with other water treatment methods. For studying the physical-chemical properties of the catholyte and anolyte the evaluation of the possible number of hydrogen bonds as percent of H<sub>2</sub>O molecules with different values of distribution of energies was carried out. These distributions suggest about the restructuring of H<sub>2</sub>O molecules with the same energies. This serves as the mathematical model explaining the behavior of anolyte and catholyte regarding the distribution of H<sub>2</sub>O molecules to the energies of hydrogen bonds.

#### References:

- Aider, M., Kastyuchik, A., Gnatko, E., Benali, M. & Plutakhin, G. (2012) Electro-activated aqueous solutions: theory and application in the food industry and biotechnology. *Innovative Food Science & Emerging Technologies*, **15**: 38–49.
- Antonov, A. (1995) *Research of the Nonequilibrium Processes in the Area in Allocated Systems*. Diss. thesis doctor of physical sciences. Sofia: Blagoevgrad: 1–255.
- Atanasov, A., Karadzhov, S., Ivanova, E., Mosin, O.V. & Ignatov I. (2014) Study of the effects of electrochemical aqueous sodium chloride solution (anolyte) on the virus of classical swine fever virus. Mathematical models of anolyte and catholyte as types of water. *Journal of Medicine, Physiology and Biophysics*, **4**: 1–26.
- Bahir, V.M., Liakumovich, A.G., Kirpichnikov, P.A., Spector, L.E. & Mamajanov, U.D. (1983) The physical nature of the phenomenon of activation substances. *Izv. UzSSR. Ser. Tehn. Sciences*, **1**: 60–64.
- Bahir, V.M. (1992) *Electrochemical activation*. – Moscow: All Russian Scientific Research and Experimental Institute of Medical Engineering (VNIIMT), **2**: 632–657 [in Russian].
- Bahir, V.M., Zadorozhnyi, Y.G., Leonov, B.I., Panicheva, S.A. & Prilutsky, V.I. (2001) *Electrochemical activation: water purification and production of useful solutions*. – Moscow: VNIIMT, **1**: 100–176 [in Russian].
- Dykstra, C.E. (1999) External electric field effects on the water trimer. *Chemical Physics Letters*, (2)299: 132–136.
- Edwards, A. & Edwards, S. (2000) Survival and inactivation of classical swine fever virus. *Veterinary Microbiology*, **73**: 175–181.
- Hsu, S.Y. (2005) Effects of flow rate, temperature and salt concentration on chemical and physical properties of electrolyzed oxidizing water. *Journal of Food Engineering*, **66**: 171–176.

- Ignatov, I. & Mosin, O.V. (2013) Structural Mathematical Models Describing Water Clusters. *Journal of Mathematical Theory and Modeling*, **3**(11): 72–87.
- Ignatov, I. & Mosin, O.V. (2014) Methods for Measurements of Water Spectrum. Differential Non-equilibrium Energy Spectrum Method (DNES). *Journal of Health, Medicine and Nursing* **6**: 50-72.
- Ignatov, I., Karadzov, S., Atanasov, A., Ivanova, E. & Mosin, O.V. (2014) Electrochemical aqueous sodium chloride solution (anolyte and catholyte) as types of water. Mathematical models. Study of effects of anolyte on the virus of classical swine fever virus. *Journal of Health, Medicine and Nursing*, **8**: 1–28.
- Inoue, Y., Endo, S., Kondo, K., Ito, H., Omori, H. & Saito, K. (1997) Trial of electrolyzed strong acid aqueous solution lavage in the treatment of peritonitis and intraperitoneal abscess. *Artificial Organs*, **21**(1): 28–31.
- Karadzov, S., Atanasov, A., Ivanova E., Mosin, O.V., Ignatov, I. (2014) Mathematical models of electrochemical aqueous sodium chloride solutions (anolyte and catolyte) as types of water. Study of the effects of anolyte on the virus of classical swine fever virus. *Journal of Health, Medicine and Nursing*, **5**: 30–55.
- Kim, C., Hung, Y.C. & Brackett, R.E. (2000) Roles of oxidation-reduction potential in electrolyzed oxidizing and chemically modified water for the inactivation of food-related pathogens. *Journal of Food Protection*, **63**: 19–24.
- Kirpichnikov, P.A., Bahir, V.M. & Hamer, P.U. (1986) On the nature of electrochemical activation of media. *Dokl. USSR Academy of Sciences*, **286**(3): 663–666.
- Kirkpatrick, R.D. (2009) *The Mechanism of antimicrobial action of electro-chemically activated (ECA) water and its healthcare applications*. Doctoral Thesis, University of Pretoria.
- Kloss, A.I. (1988) Electron-radical dissociation and mechanism of water activation. *Trans. Acad. Sc. USSR*, **303**: 1403–1406.
- Kumar, S.V., Ezeike, G.O., Hung, Y.C. & Doyle, M.P. (1999) Efficacy of electrolyzed oxidizing water for inactivating *Escherichia coli* O157:H7, *Salmonella enteritidis*, and *Listeria monocytogenes*. *Applied and Environmental Microbiology*, **23**: 4276–4279.
- Leonov, B.I., Prilutsky, V.I. & Bahir, V.M. (1999a) *Physical-chemical aspects of the biological effect of electrochemically activated water*. – Moscow: VNIIMT, **1**: 224–240 [in Russian].
- Leonov, B.I., Bahir, V.M. & Vtorenko, V.I. (1999b) Electrochemical activation in the practice of medicine / in: *2<sup>nd</sup> International Symposium “Electrochemical Activation”*. Proc. rep. and brief reports. – Moscow, **1**: 15–23 [in Russian].
- Luck, W., Schiöberg, D. & Ulrich, S. (1980) Infrared investigation of Water Structure in Desalination Membranes. *J. Chem. Soc. Faraday Trans.*, **2**(76): 136–147.
- Morita, C., Sano, K., Morimatsu, S., Kiura, H., Goto, T. & Kohno, T. (2000) Disinfection potential of electrolyzed solutions containing sodium chloride at low concentrations. *Journal of Virological Methods*, **85**(2): 163–174.
- Mosin, O.V. (2012) Electrochemical treatment of water. *Santechnics Heating Air Conditioning. C.O.K.* – Moscow: Media Technology, **10**: 20–26.
- Petrushanko, I.Ju. & Lobyshev, V.I. (2001) Non-equilibrium state of electrochemically activated water and its biological activity. *Biofizika*, **46**(3): P. 389–401.
- Petrushanko, I.Ju. & Lobyshev, V.I. (2004) Physico-chemical properties of aqueous solutions, prepared in a membrane electrolyzer. *Biofizika*, **49**(1): 22–31.
- Prilutsky, V.I. & Bakhir, V.M. (1997) *Electrochemically activated water: Anomalous properties, Mechanism of biological action*. – Moscow: VNIIMT, **1**: 124 p. [in Russian].
- Sands, J.A., Landin, P. & Auperin, D. (1979) Enveloped virus inactivation by fatty acid derivatives. *Antimicrob. Agents Chem.*, **15**: 134–136.
- Shimada, K., Ito, K. & Murai, S. (2000) A comparison of the bactericidal effects and cytotoxic activity of three types of oxidizing water, prepared by electrolysis, as chemical dental plaque control agents. *International Journal of Antimicrobial Agents*, **15**(1): 49–53.
- Springthorpe, U.S. & Sattar, S.A. (1990) Chemical disinfection of virus-contaminated surfaces. *Crit. Rev.*

*Environ. Control.*, **20**: 169–229.

Stoner, G.E., Cahen, G.L.Jr., Sachyani, M. & Gileadi, E. (1982) The mechanism of low frequency a.c. electrochemical disinfection. *Bioelectrochemistry and Bioenergetics*, **9**(3): 229–24.

Suzuki, T., Itakura, J., Watanabe, M., Ohta, M., Sato, Y. & Yamata, Y. (2002) Inactivation of staphylococcal Enterotoxin-A with an electrolyzed anodic solution. *Journal of Agricultural and Food Chemistry*, **50**: 230–234.

Tanaka, H., Hirakata, Y., Kaku, M., Yoshida, R., Takemura, H. & Mizukane, R. (1996) Antimicrobial activity of superoxidized water. *Journal of Hospital Infection*, **34**(1): 43–49.

Toropkov, V.V., Altshul, E.B. & Peresyppkin, O.I. (1999) Therapeutic efficacy of anolyte and ANC on the mucous membranes of the oral cavity / in: *2<sup>nd</sup> International Symposium “Electrochemical Activation”*. – Moscow, **1**: 93–95.

Toropkov, V.V., Altschul, E.B. & Toropkova, E.V. (2001) Toxicological characterization of catholyte / in: *3d International Symposium “Electrochemical Activation”*. – Moscow-Leningrad, **1**: 57–62.

Yahagi, N., Kono, M., Kitahara, M., Ohmura, A., Sumita, O. & Hashimoto, T. (2000) Effect of electrolyzed water on wound healing. *Artificial Organs*, **24**(12): 984–987.

Zinkevich, V., Beech, I.B., Tapper, R. & Bogdarina, I. (2000) The effect of super-oxidized water on *Escherihia coli*. *Journal of Hospital Infection*, **46**: 153–156.